

FOREST[®]

DRAPERY HARDWARE



CCC[®]
Corded Contract System

CCS[®] Corded Contract System

Product information

- Heavy duty cord operated system, with separate internal cord channels; preventing cord sag and eliminating cord tangle.
- Bendable; it can be curved and reversed curved with a 20 cm (8") radius or continuous curve.
- Heavy duty clickable carriers - 10 carriers on a breakaway strip - UV protected.
- Can also be used for Forest Easyfold and accordiafold drapery systems.
- Maximum fabric weight: 8 kg. per mtr (5,3 LBS per ft).
- Colours available: white, silver.
- Track finish: chromated powder coating with a factory applied patented dry lubricant.
- Lengths available: 3.66 m (12'), 4.27 m (14'), 4.88 m (16'), 6.10 m (20').

Profile

- Shown actual size 1:1
- Aluminium Extrusion
- Weight: 300 gram per mtr (3.22 ounce per ft)
- Dimensions: 20 mm x 20 mm (3/4" x 3/4")

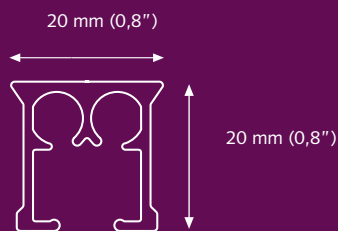

For use in

Hotels - motels - offices - healthcare - schools - residential or any location where a heavy duty cord traverse system is required.

Applications

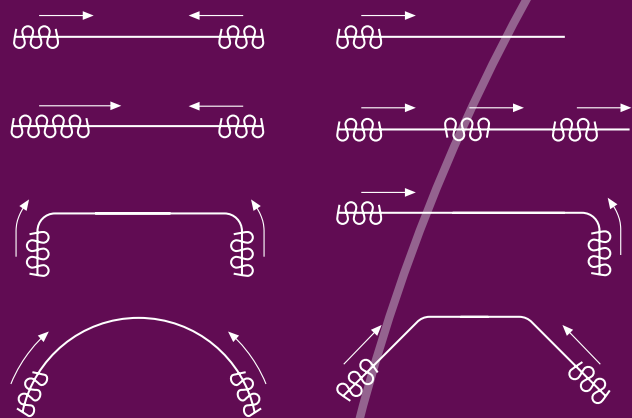

Bending/curving

The track can be curved and reversed curved using a 20 cm (8") radius. Continuous curving can be done with the electric powered bender or by special order from factory.

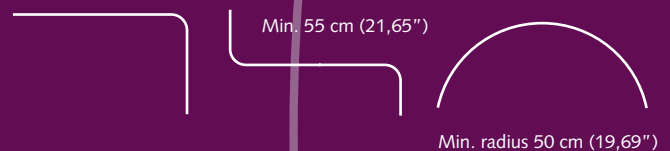

- ① Carrier
- ② CCS/FMS Master Carrier Underlap
- ③ Traverse cord
- ④ CCS/FMS Master Carrier Overlap
- ⑤ CCS Cord connector
- ⑥ CCS Track
- ⑦ Pulley

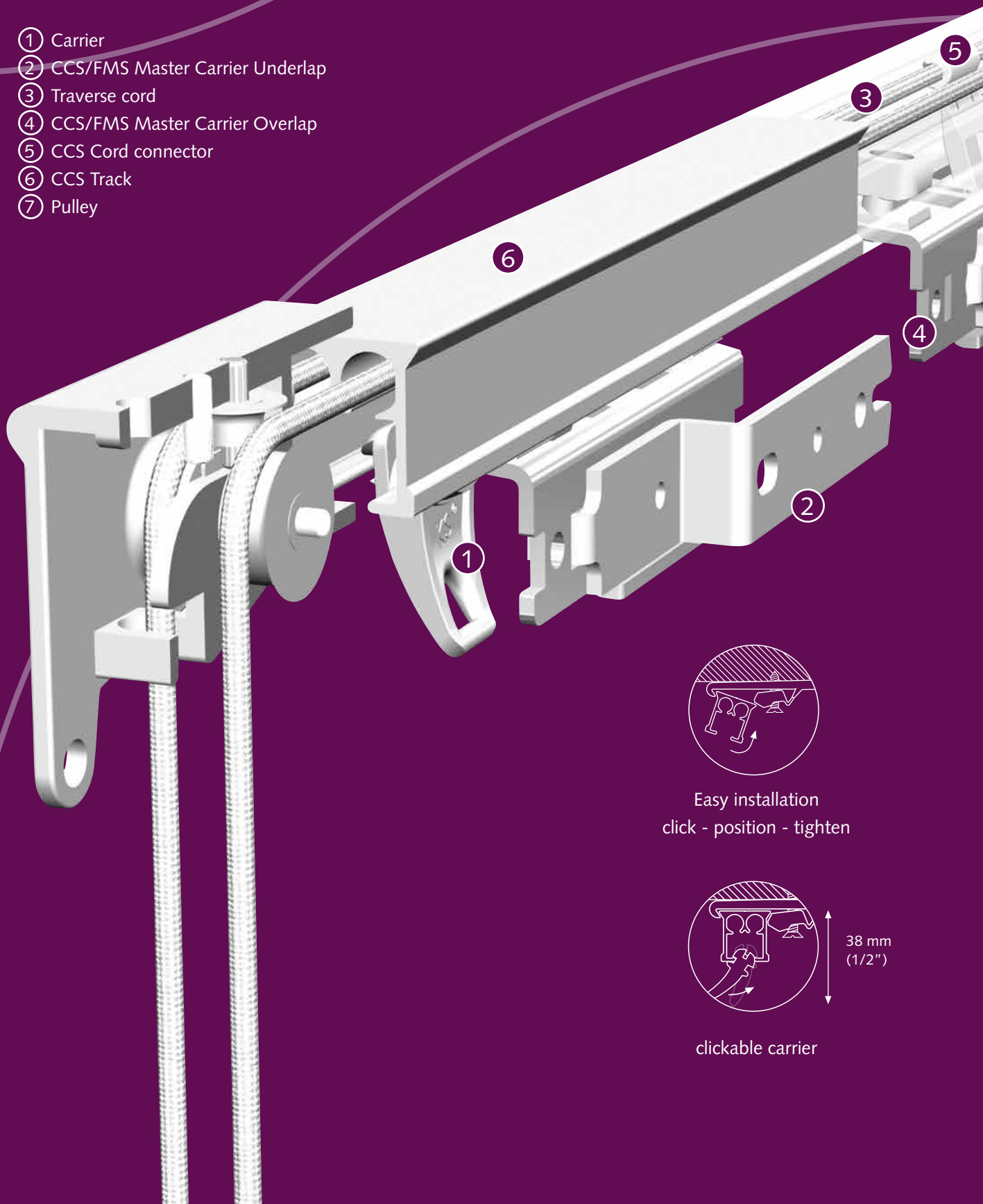

Easy installation
click - position - tighten



38 mm
(1/2")

clickable carrier

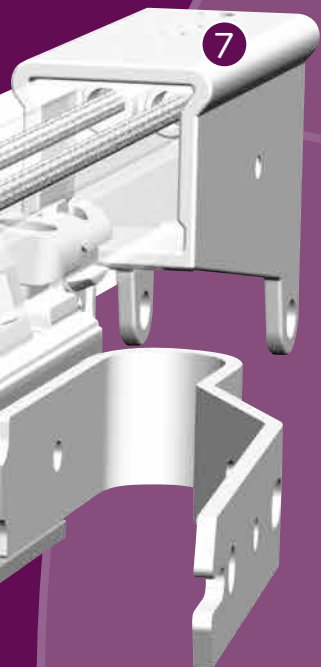

Mounting Brackets

Aluminium Wall Bracket single

A) 7,5 cm (3"): B) 6,3 cm (2")
 A) 10 cm (4"): B) 8,8 cm (3")

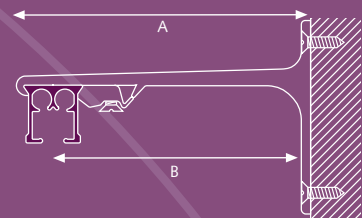

Ceiling bracket

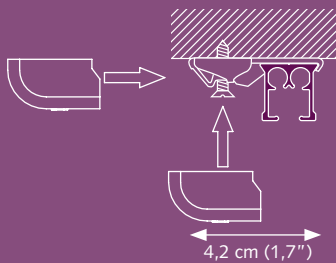

A) Min. 20 cm (8")



Aluminium Wall Bracket double

A) 15 cm (6"): B) 9,2 cm (3"), C) 4,5 cm (2")
 A) 20 cm (8"): B) 9,2 cm (3"), C) 9,5 cm (4")

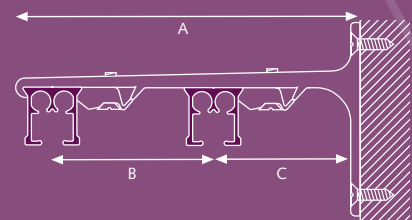

Aluminium Wall Bracket triple

25 cm (10")

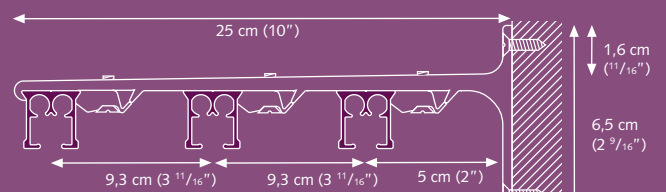

Brackets need to be placed every 60 cm (24").

Colours available from stock:

Complete the art.nr. with the indicated colour-code

01 White, 03 Silver, 05 Brown, 06 Black

Other colours can be delivered on request.

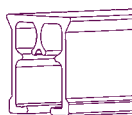
**CCS Track**

Extruded aluminium chromated, powder coated. Factory lubricated for wall or ceiling mounting. Inches 3.66 m. (12'), 4.27 m. (14'), 4.88 m. (16'), 6.10 m. (20'). Colours: 01, 03.

30010...cm
10/bundle**CS/CCS/FMS CARRIER SMALL**

Contract click carrier patented, clickable. UV-resistant POM plastic.

25101.. 000
250/box

Colours: 01, 02, 03, 05, 06.

**CS/CCS/FMS CARRIER SMALL TRANSPARENT PE**

Contract click carrier, patented, clickable. Made of PE plastic to reduce noise, lightweight curtains only.

251010000
250/box**Silence Carrier**

Reduces resonance in the CCS track, for light weight curtains.

2510301000
250/box

Colours: 01.

**FMS/CCS/MRS Wheel Carrier**

The wheel carrier goes smoothly over a splice.

5210101002
100/box**CS/CCS/FMS Track Joiner**

Used to make a solid connection between two pieces of track.

25184..000
10/box

Colours 01, 05, 06

**CCS Cord Master Carrier R/L Underlap**

Multifunctional - reversible arm - will go through curves. Colours: 01, 03.

3015601000
15/box**CCS Cord Master Carrier R/L Overlap**

Multifunctional - reversible arm - will go through curves, will also fit stiffeners and cord connector. Colours: 01, 03.

3015701000
15/box**CCS/FMS Master Carrier R/L Underlap Single**

Multifunctional - arm is reversible - will slide through curves. Colours: 01.

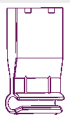
3016001000
15/box**CCS Cord Connector**

Connects cord to the CCS master carrier.

3030301000
100/box

Colours: 01, 03, 05, 06.

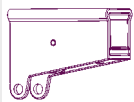
**Pulley**

Reversible, for two way draw.

30301.. 000
25/box

Colours: 01, 03, 05.

**End Pulley Small**

Reversible, for non-stacking side on one way draw.

30302.. 000
25/box

Colours: 01, 03, 05.

**Inside Wall Bracket**

For additional support anywhere the pulley meets the wall.

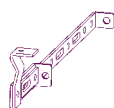
3022301000
25/box**Straight Return R/L**

Adjustable from 7,5 cm (3") to 25 cm (10").

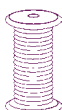
3022501000
10/box**Traverse Cord**

Nylon drapery cord designed for strong smooth slide, Ø 3.5 mm (0,14"), 16 ply. Colours: 01, 03, 06.

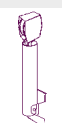
10304..000
250 mtr/roll**Tension Pulley**

Metal.

1030501000
25/box

Colours: 01.

**Cord Weight**

Plastic.

3030601000
20/box

Colours: 01.

**Cord Safety Clip**

Plastic.

3645702000
25/box

Colours: 01.

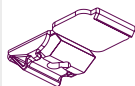
**Smart Klick Ceiling Bracket**

"Klicks" onto track, powder coated. Install with VK screw 4 mm.

10182..000
100/boxInclusive Covercap
Colours: 01, 03, 05, 06.

1018201001

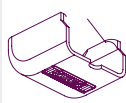
**Covercap for Smart Klick Ceiling Bracket**

Fits on Smart Klick Wall and Ceiling bracket.

10192..000
100/box

Colours: 01, 03, 05, 06.

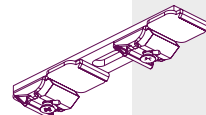
**Smart Klick Double Ceiling Bracket Large**

Distance between two tracks: 90 mm (3,5")

1018601000
30/box**Smart Klick Double Ceiling Bracket Short**

Distance between two tracks: 45 mm (1,8")

1018611000
30/box**False Ceiling Bracket (metal)**

For installation on to a suspended ceiling. The track can be fixed in any angle.

100/box
4519001000**FSS Mounting Bracket**

For concealed installation or ceiling installation in narrow spaces. Heavy Duty.

100/box
7160001000

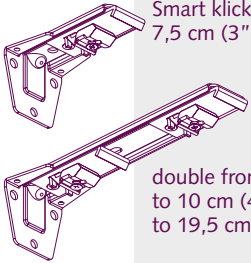

Adjustable Wall Bracket
Smart klick, adjustable single from 7,5 cm (3") to 11,5 cm (4.5")

10208..115
100/box

double from 6,5 cm (2,5") to 10 cm (4") - 15 cm (6") to 19,5 cm (7,5")

10208..195
50/box



Bending Standard
Standard for Contract bending tool

256080000
1/each



Electric Powered Bender
Available in 230V or 115V, to create continuous curves and arches. Minimum radius 50 cm (20").

106050000
1/box

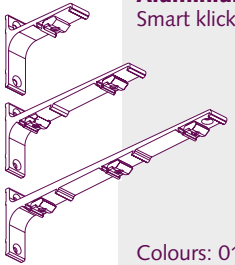

Aluminium Wall Bracket
Smart klick, powder coated.

10203.. ...cm

7,5 cm single	(3")	20/box
10 cm single	(4")	20/box
15 cm double	(6")	15/box
20 cm double	(8")	15/box
25 cm triple	(10")	10/box

Colours: 01, 03.



Bending Wheels
For Electric Powered Bender. Complete set of 3 wheels.

256070000
1/set

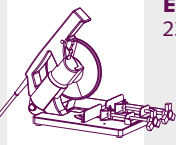

Electric Powered Railcutter
230 Volt EU

106110000

Replacement Blade
For electric powered railcutter.

106120000
1/each

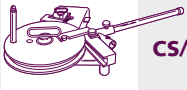

Contract Bending tool
For CS/CCS/FMS/CRS/MTS

256000000
1/each

CS/CCS/FMS Bending Wheel
256100000
1/each

Distributor:

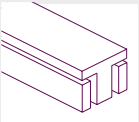

CCS Bending Strips
For CCS track, length: 90 cm (35,4")

850000002
1/set

For CCS electric powered bender. Length 7 meter (23').

850000010
1/each

FOREST
DRAPERY HARDWARE

Download
Forest brochures

