

**Colours available from stock:**  
Complete the art.nr. with the indicated colour-code  
**01 White, 03 Silver, 05 Brown.**  
Other colours can be delivered on request.

**CCS Track** 30010... ..cm  
Extruded aluminium chromated,  
powder coated. Factory lubricated.  
White: 3.66 m (12'), 4.27 m (14'), 4.88 m (16'),  
6.10 m (20'). Silver: 4.88m (16'), 6.10m (20')  
Brown: 6.10 m (20')

**CS/CCS/FMS CARRIER SMALL** 25101.. 000  
Contract click carrier patented,  
clickable. UV-resistant POM plastic.  
250/box  
Colours: 01, 03, 05.

**FMS/CCS/MRS Wheel Carrier** 5210101002  
The wheel carrier goes smoothly  
over a splice.  
100/box

**CS/CCS/FMS Track Joiner** 25184..000  
Used to make a solid connection  
between two pieces of track.  
10/box  
Colours 01, 03, 05.

**CCS Cord Master Carrier R/L Underlap** 3015601000  
Multifunctional - reversible arm  
- will go through curves.  
15/box  
Colours: 01, 03.

**CCS Cord Master Carrier R/L Overlap** 3015701000  
Multifunctional - reversible arm - will go  
through curves, will also fit stiffeners and  
cord connector. Colours: 01, 03.  
15/box

**CCS/FMS Master Carrier R/L Underlap Single** 3016001000  
Multifunctional - arm is reversible -  
will slide trough curves.  
15/box  
Colours: 01, 03.

**CCS Cord Connector** 3030301000  
Connects cord to the CCS master  
carrier.  
100/box  
Colours: 01, 03, 05.

**CCS Double Cord Connector** 3030301010  
Connects cord to the CCS master  
carrier.  
20/box  
Colours: 01, 03.

**Pulley** 30301.. 000  
Reversible, for two way draw.  
25/box  
Colours: 01, 03, 05.

**End Pulley Small** 30302.. 000  
Reversible, for non-stacking side  
on one way draw.  
25/box  
Colours: 01, 03, 05.

**Inside Wall Bracket** 3022301000  
For additional support anywhere the  
pulley meets the wall.  
25/box

**Straight Return R/L** 3022501000  
Adjustable from 7,5 cm (3")  
to 25 cm (10").  
10/box

**Traverse Cord** 10304..000  
Nylon drapery cord designed for  
strong smooth slide, Ø 3.5 mm  
(0,14"), 16 ply.  
250 mtr/roll  
Colours: 01, 03.

**Tension Pulley** 1030501000  
Metal.  
25/box  
Colours: 01.

**Cord Chain Weight Design** 10/box  
110 gr  
White 3030701000  
Grey 3030703000  
Black 3030706000

**Cord Safety Clip** 3645702000  
Plastic.  
25/box  
Colours: 01.

**Smart Klick Ceiling Bracket** 100/box  
"Klicks" onto track, powder coated.  
White included cover cap 1018201001  
Silver included cover cap 1018203001  
Brown include cover cap 1018205001

**Smart Klick Double Ceiling Bracket Large** 1018601000  
Distance between  
two tracks: 90 mm (3,5")  
30/box

**Smart Klick Double Ceiling Bracket Short** 1018611000  
Distance between two tracks:  
45 mm (1,8")  
30/box

**False Ceiling Bracket (metal)** 100/box  
For installation on to a suspended  
ceiling. The track can be fixed in  
any angle.  
4519001000

**FSS Mounting Bracket** 100/box  
For concealed installation or ceiling  
installation in narrow spaces.  
7160001000  
Heavy Duty.

**Adjustable Wall Bracket** 10208..115  
Smart klick, adjustable single from  
7,5 cm (3") to 11,5 cm (4.5")  
100/box

**double from 6,5 cm (2,5")  
to 10 cm (4") - 15 cm (6")  
to 19,5 cm (7,5")** 10208..195  
50/box  
Colours: 01, 03.

**Aluminium Wall Bracket** 10203... ..cm  
Smart klick, powder coated.  
7,5 cm single (3") 20/box  
10 cm single (4") 20/box  
15 cm double (6") 15/box  
20 cm double (8") 15/box  
25 cm triple (10") 10/box  
Colours: 01, 03.

**Smart Klick Cover Cap Alu Wall Bracket Universal** 10213..000  
Colours: 01, 03.  
50/box

**Contract Bending tool** 2560000000  
For CS/CCS/FMS/CRS/MTS  
1/each

**CS/CCS/FMS Bending Wheel** 2561000000  
1/each

**CCS Bending Strips** 8500000002  
For CCS track, length: 90 cm (35,4")  
1/set

For CCS electric powered bender.  
Length 7 meter (23'). 8500000010  
1/each

**Bending Standard** 2560800000  
Standard for Contract  
bending tool  
1/each

**Electric Powered Bender** 1060500000  
Available in 230V or 115V, to create  
continuous curves and arches.  
Minimum radius 50 cm (20").  
1/box

**Bending Wheels** 2560700000  
For Electric Powered Bender.  
Complete set of 3 wheels.  
1/set

**Electric Powered Railcutter** 1061100000  
230 Volt EU

**Replacement Blade** 1061200000  
For electric powered railcutter.  
1/each

**Forest Lubricant** 5109010000  
To lubricate components during  
assembly.  
1/box

Distributor:

# FOREST®

DRAPERY HARDWARE

# FOREST®

DRAPERY HARDWARE



**CCS®**  
**Corded Contract System**

### Product information

- Heavy duty cord operated system, with separate internal cord channels; preventing cord sag and eliminating cord tangle.
- Bendable; it can be curved and reversed curved with a 20 cm (8") radius or continuous curve.
- Heavy duty clickable carriers - 10 carriers on a breakaway strip - UV protected.
- Can also be used for Forest Easyfold and accordiafold drapery systems.
- Maximum fabric weight: 8 kg. per mtr (5,3 LBS per ft).
- Colours available: white, silver and brown.
- Track finish: chromated powder coating with a factory applied patented dry lubricant.
- Lengths available: 3.66 m (12'), 4.27 m (14'), 4.88 m (16'), 6.10 m (20').

### Profile

Shown actual size 1:1  
 Aluminium Extrusion  
 Weight: 300 gram per mtr (3.22 ounce per ft)  
 Dimensions: 20 mm x 20 mm (3/4" x 3/4")

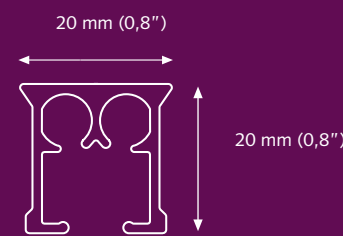

### For use in

Hotels - motels - offices - healthcare - schools - residential or any location where a heavy duty cord traverse system is required.

### Applications

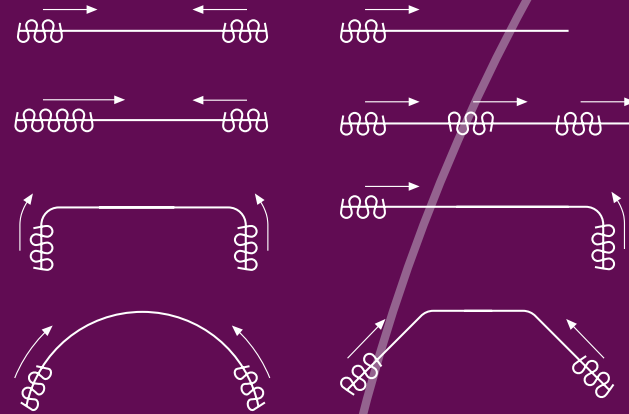

### Bending/curving

The track can be curved and reversed curved using a 20 cm (8") radius. Continuous curving can be done with the electric powered bender or by special order from factory.



- ① Carrier
- ② CCS/FMS Master Carrier Underlap
- ③ Traverse cord
- ④ CCS/FMS Master Carrier Overlap
- ⑤ CCS Cord connector
- ⑥ CCS Track
- ⑦ Pulley

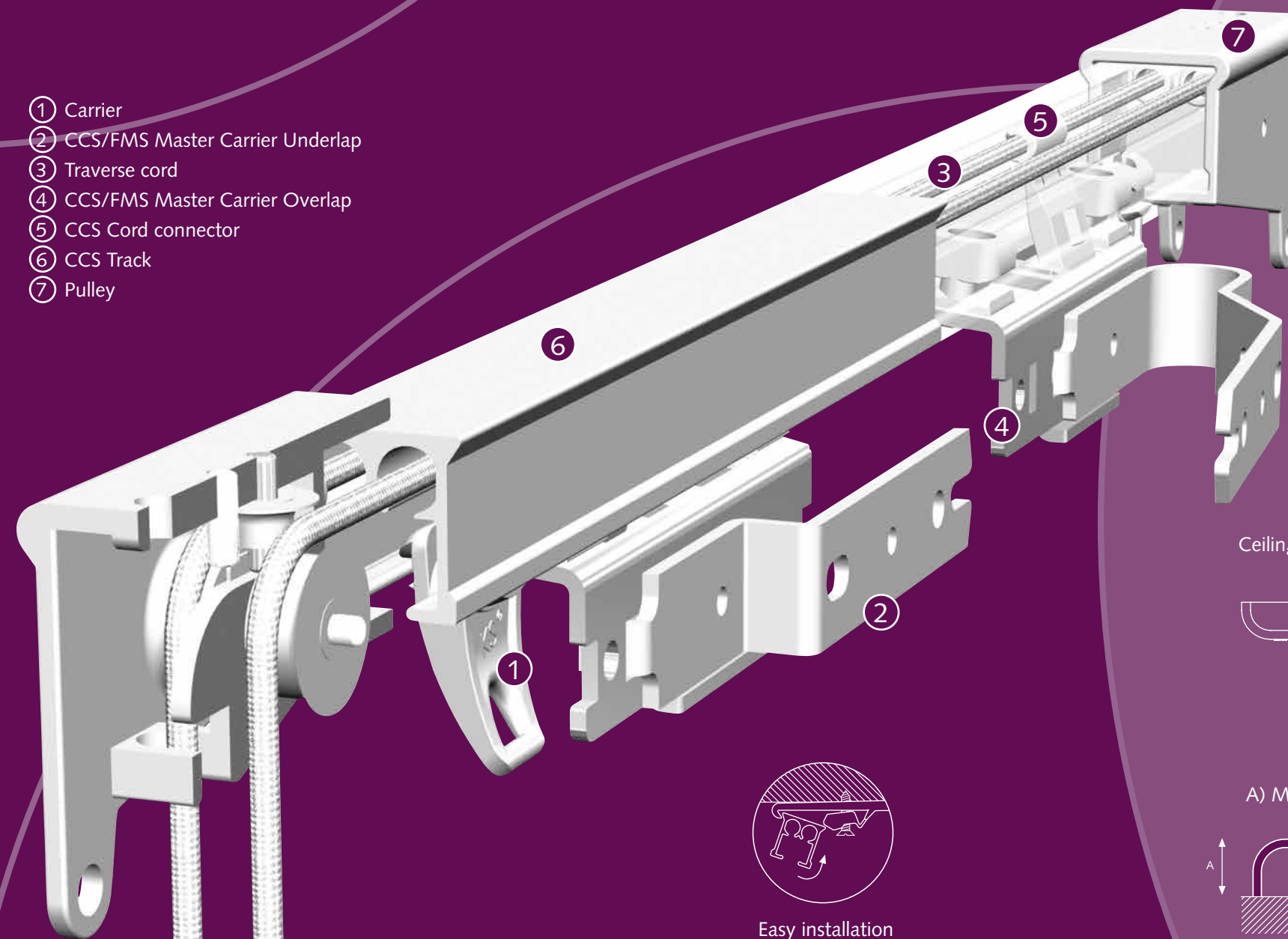

Easy installation  
 click - position - tighten

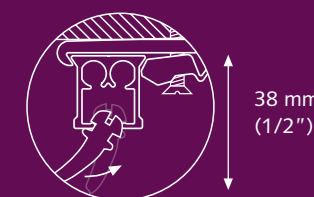

clickable carrier

### Mounting Brackets

Aluminium Wall Bracket single  
 A) 7,5 cm (3") B) 6,3 cm (2")  
 A) 10 cm (4") B) 8,8 cm (3")

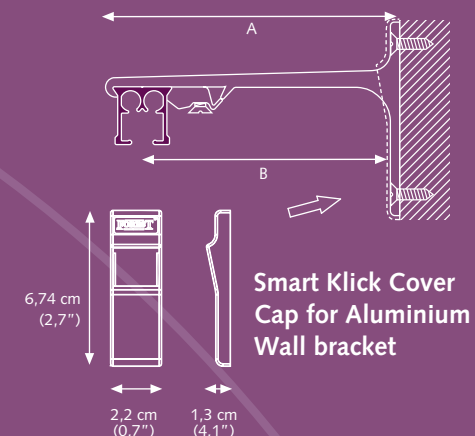

Aluminium Wall Bracket double  
 A) 15 cm (6") B) 9,2 cm (3") C) 4,5 cm (2")  
 A) 20 cm (8") B) 9,2 cm (3") C) 9,5 cm (4")

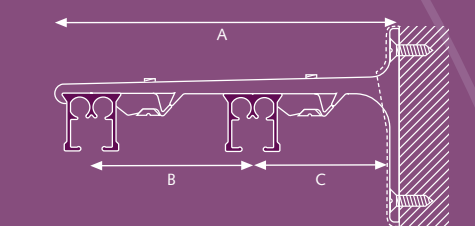

Aluminium Wall Bracket triple  
 25 cm (10")

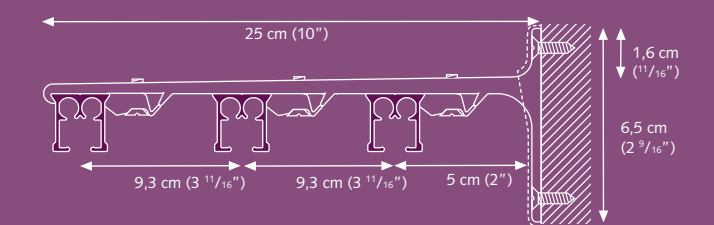

Brackets need to be placed every 50 - 60 cm (24"), depending on fabric weight.

### Ceiling bracket

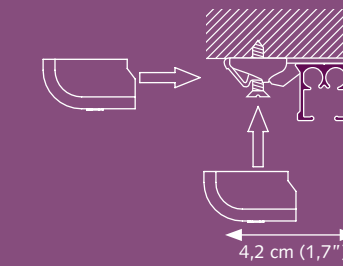

A) Min. 20 cm (8")

