



DOMOTICS
READY



APP
CONTROL



WIRELESS
REMOTE



CHAIN
CONTROL

FOREST ROMAN BLIND Series

Elegantly shaped aluminium profile with integrated Velcro Tape

FOREST BS[®]
FOREST BS[®] MAX
FOREST BCS[®]
FOREST BS[®] WIRED/BATTERY POWERED
FOREST BS[®] MAINS 12V

THE WORLD
BEHIND
YOUR
CURTAINS



FOREST BLIND SYSTEM - BS®



For a more streamlined look or when space is at a premium, roman blinds that stack neatly at the top of the window when retracted are the perfect solution. With the Blind System - BS® of Forest a sleek natural look is provided for your interior. Experience the simplicity of chain operation for Roman blinds. With an easy-to-use chain mechanism, adjusting the blinds to your desired position is effortless.

The Blind System - BS® is the most widely used and recognised roman blind in the industry. It comes with integrated velcro tape so that the fabric can be easily attached & removed. The system is always correctly aligned due to the twistlock on the cord roll support. For the ultimate convenience a motorised control option is possible. Operate the Blind System at the press of a button or by your smartphone. See for more info about motorised options check further down in this brochure.

PRODUCT INFORMATION

- Compact hand drawn roman blind system.
- For all types of light and medium weight draperies.
- Elegant shaped aluminium profile, with integrated Velcro hook tape.
- Application width: min. 38 cm & max 5.80 meter (19").
- Available height: 3.50 meter (11.5").
- Simple face-fix and top fix installation.
- Conic shaped drums; thus smooth and straight operation of the system is guaranteed.
- Control unit options:
 - 1:1 (fabric weight up to 3,5 kg)
 - 1:4 (fabric weight up to 7,5 kg)
- Total maximum fabric weight up to 7,5 kg.
- Colour available: white.
- Special Child Safety solution possible (1:4 & 1:4).
- Track finish: Aluminium powder coated.
- Warranty Manual System: 10 year.

FOR USE IN

Hotels, offices, residences, boats or anywhere an efficient Velcro track system for roman shades is required.

CONTROL OPTIONS





PROFILE

- Weight 409 gr/mtr
- Aluminium extrusion 6063 T5
- Size 33.3 x 36.7 mm (1.3" x 1.4")
- Colour available: white

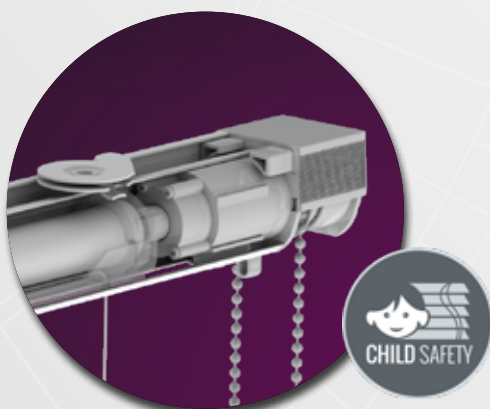
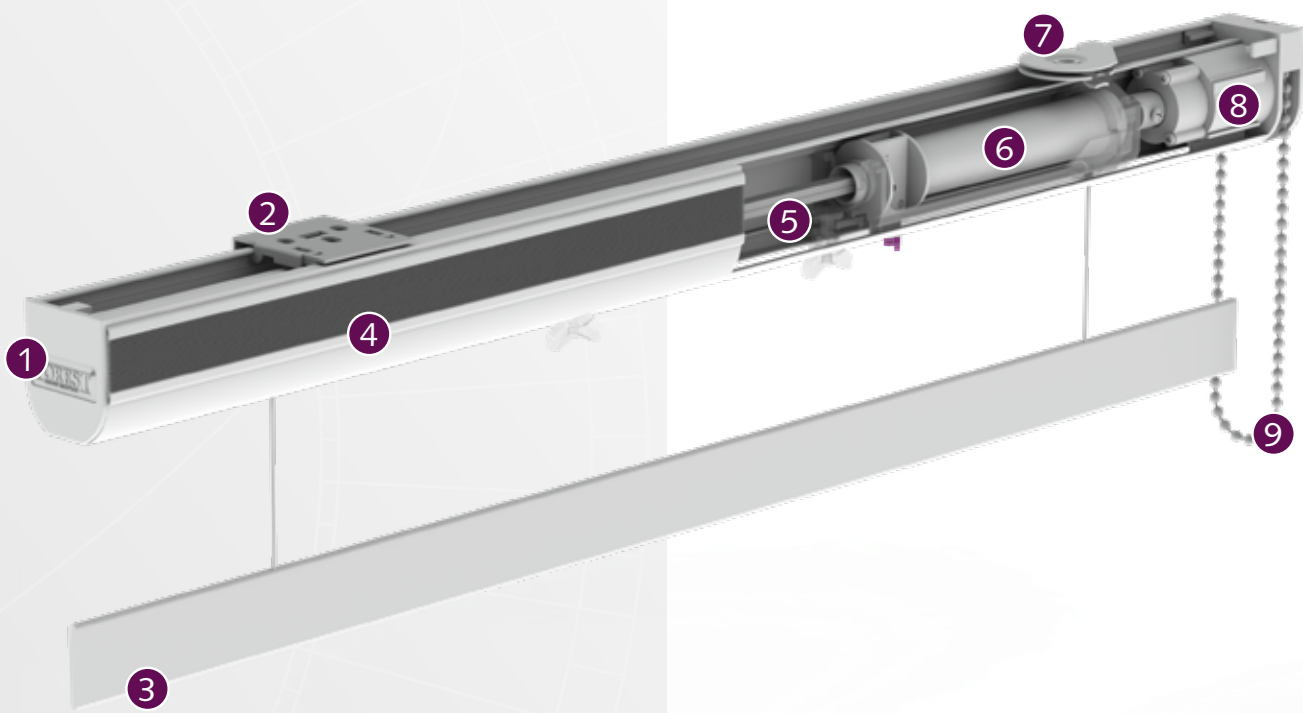
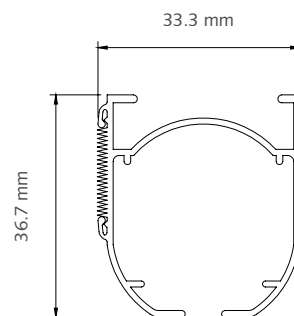

- ① BS Endcap
- ② BS Smart Klick® Ceiling / Wall Bracket
- ③ Counterweight bar 6 x 20 mm
- ④ BS Track incl. Velcro Hook Tape
- ⑤ BS Rod 5x5 mm
- ⑥ BS Quicklock Cord Roll
- ⑦ BS Ceiling bracket, swivel
- ⑧ BS Control Unit 1:4
- ⑨ Chain

FOREST BS® MOTOR (WIRED/BATTERY)



The Blind System - BS® is the most widely used and recognised roman blind in the industry. It comes with integrated velcro tape so that the fabric can be easily attached & removed. The system is always correctly alligned due to the twistlock on the cord roll support. For the ultimate convenience a motorised control option is possible. Operate the Blind System at the press of a button or by your smartphone.

The Bluetooth capabilities of this system works with our Forest Connect App, this feature separates it from the current industry offering.

Discover the convenience and elegance of battery-powered BS® Roman blind system. Enjoy the luxury of motorised blinds without the hassle of complex wiring. Effortlessly operate them using a switch or remote control or by app, adding a touch of sophistication to your space.

PRODUCT INFORMATION

- Dual power options; wired or battery powered.
- Motor **including Bluetooth capabilities.**
- Works directly with our Forest Connect App.
- Can be connected to the power grid with a power adapter.
- Application width: min. 53 cm (20.87") & max 5.80 meter (19').
- Available height: 3.50 meter (11.5').
- Maximum fabric weight per cord roll: 1 kg and total system 4 kg.
- Track finish: durable, high-quality aluminium with a powder-coated finish.
- Colour available: white.
- Equipped with Forest Link RF protocol.
- Charging motor takes 6-8 hours or until the blue light comes on
- 6 month battery life (1 up & 1 down).
- Min size available 51cms.
- 5 year warranty on motor.
- 2 Year warranty on the battery pack.

FOR USE IN

Hotels, offices, residences, boats or anywhere an efficient motorised Velcro track system for roman shades is required.

CONTROL OPTIONS





PROFILE

- Weight 409 gr/mtr
- Aluminium extrusion 6063 T5
- Size 33.3 x 36.7 mm (1.3" x 1.4")
- Colour available: white

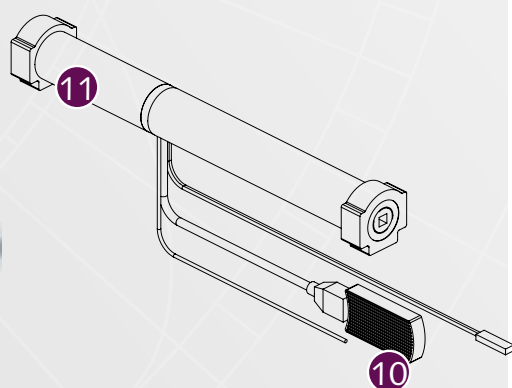
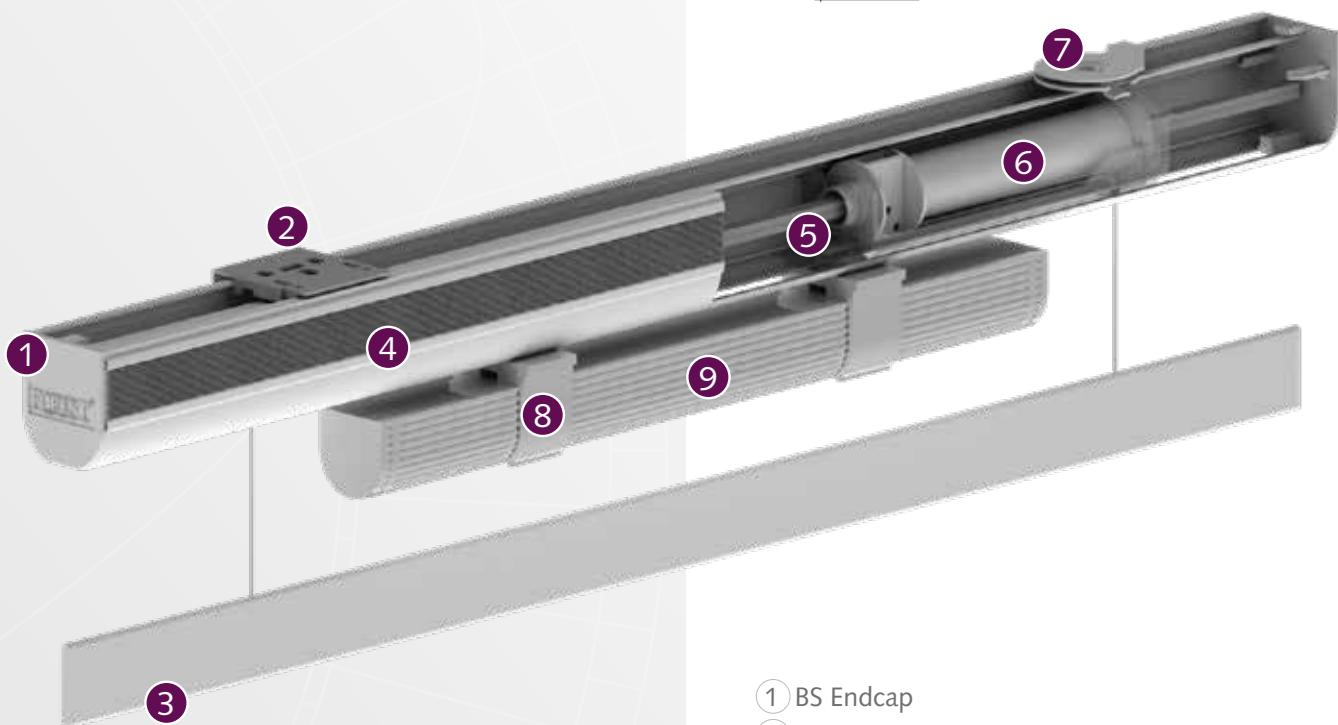
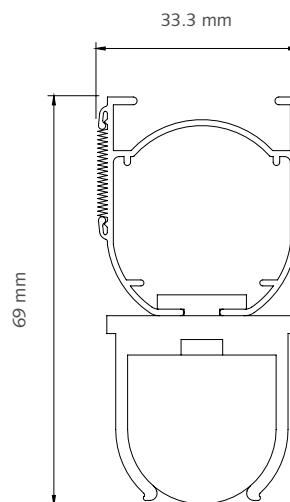

- 1 BS Endcap
- 2 BS Smart Klick® Ceiling / Wall Bracket
- 3 Counterweight bar 6 x 20 mm
- 4 BS Track incl. Velcro Hook Tape
- 5 BS Rod 5 x 5 mm
- 6 BS Quicklock Cord Roll
- 7 BS Ceiling bracket, swivel
- 8 Battery bracket
- 9 Battery pack
- 10 Bluetooth
- 11 Battery-powered BS Motor



FOREST BLIND SYSTEM MAX - BS MAX®



To complement the manual range of the roman blind systems for heavier duty drapery, Forest introduces the Blind System Max®.

The Forest BS Max® is developed for taller windows and heavier fabrics. This roman blind system can go up to a height of 4.80 meter with a total weight of 13 kg. It comes with integrated velcro tape so that the fabric can be easily attached & removed.

PRODUCT INFORMATION

- Hand drawn roman blind system.
- For all types of medium and heavy weight draperies.
- Elegant shaped aluminium profile, with integrated Velcro hook tape.
- Application width: min. 38 cm & max 5.80 meter (19").
- Available height: 4.80 meter (15.75").
- Simple face-fix and top fix installation.
- Cords are easy to remove; very useful when washing or dry cleaning the fabric.
- Self-braking endless chain control units.
- Maximum fabric weight per cord roll: 4 kg and total system 13 kg.
- Colour available: white.
- Track finish: durable, high-quality aluminium with a powder-coated finish.
- 10 year warranty.

FOR USE IN

Hotels, offices, residences, boats, campers, planes or anywhere an efficient Velcro track system for roman shades is required.

CONTROL OPTION





PROFILE

- Weight 694 gr/mtr
- Aluminium extrusion 6063 T5
- Size 53.2 x 53.5 mm (2.0" x 2.1")
- Colour available: white

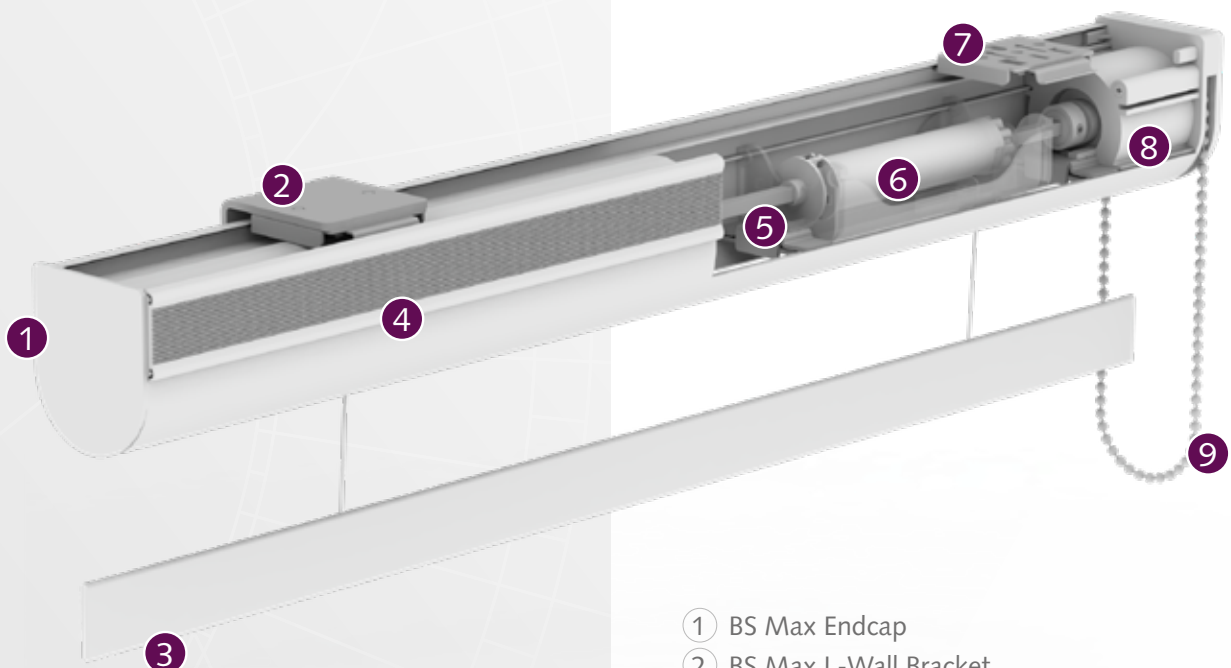
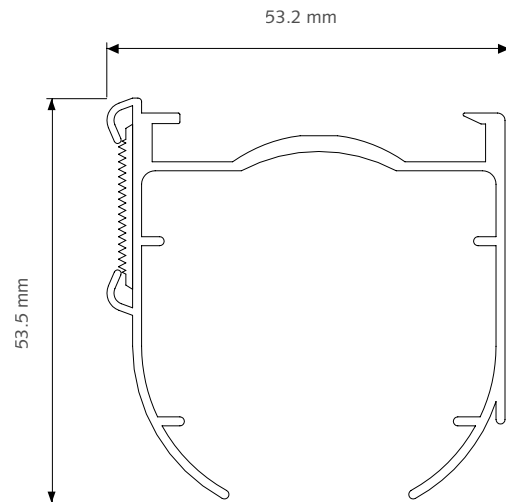

- 1 BS Max Endcap
- 2 BS Max L-Wall Bracket
- 3 Counterweight bar 6 x 20 mm.
- 4 BS Max Track incl. Velcro Hook Tape
- 5 BS Rod 5 x 5mm
- 6 BS Max Cord Drum
- 7 BS Max Hidden Ceiling Bracket
- 8 BS Max Control Unit 1:4
- 9 Chain

FOREST BLIND CONTRACT SYSTEM - BCS®



Another solution of Forest is the motorised roman blind 'BCS®-system', developed especially for taller window frames and heavier fabrics. The tubular motor in the system is 230 Volt and available in variable voltages as required. A powerful 121 Watt motor is standard, capable of lifting blinds of up to 13 kg; other motor types - capable of up to 26 kg - are available upon request. The cord spools can hold 5.5 meter of cord.

The Forest roman blind BCS® system is suitable for all current control systems and incorporates a unique, patented cord braking system. If, for any reason, the roll down action of a blind is obstructed, the motor automatically trips out to prevent the blind leaning and the cord breaking.

FOR USE IN

Domestic and/or project market, or at any location where a high quality and smooth operated motorized blind system is requested.

PRODUCT INFORMATION

- Motorised roman blind system.
- For all types of medium and heavy weight draperies.
- Elegantly shaped aluminium profile, with Velcro Hook Tape
- Application width: min. 65 cm & max 5.80 meter (19").
- Available height: 5.50 meter (18").
- Simple and quick installation with Smart Klick® bracket.
- Cords are easy to remove; very useful when you want to wash or dry cleaning the fabric.
- Can be controlled by wall switch, remote control (high frequency).
- Easy to connect to building automation systems.
- Easy to connect with third party Apps (Apple Homekit or Google Assistant) by the Forest Wireless Connector.
- Cord Drums can be placed on every position in the profile.
- Maximum fabric weight per cord roll: 4 kg.
- Tubular motor also available with internal Multi receiver and electronic limit setting.
- Track finish: durable, high-quality aluminium with a powder-coated finish.
- Warranty Manual System: 10 year.
- Warranty Motorised System: 5 year.

CONTROL OPTIONS





PROFILE

- Weight 1092 gr/mtr
- Aluminium extrusion 6063 TS
- Size 63 x 74 mm (2.4" x 2.9")
- Colour available: white

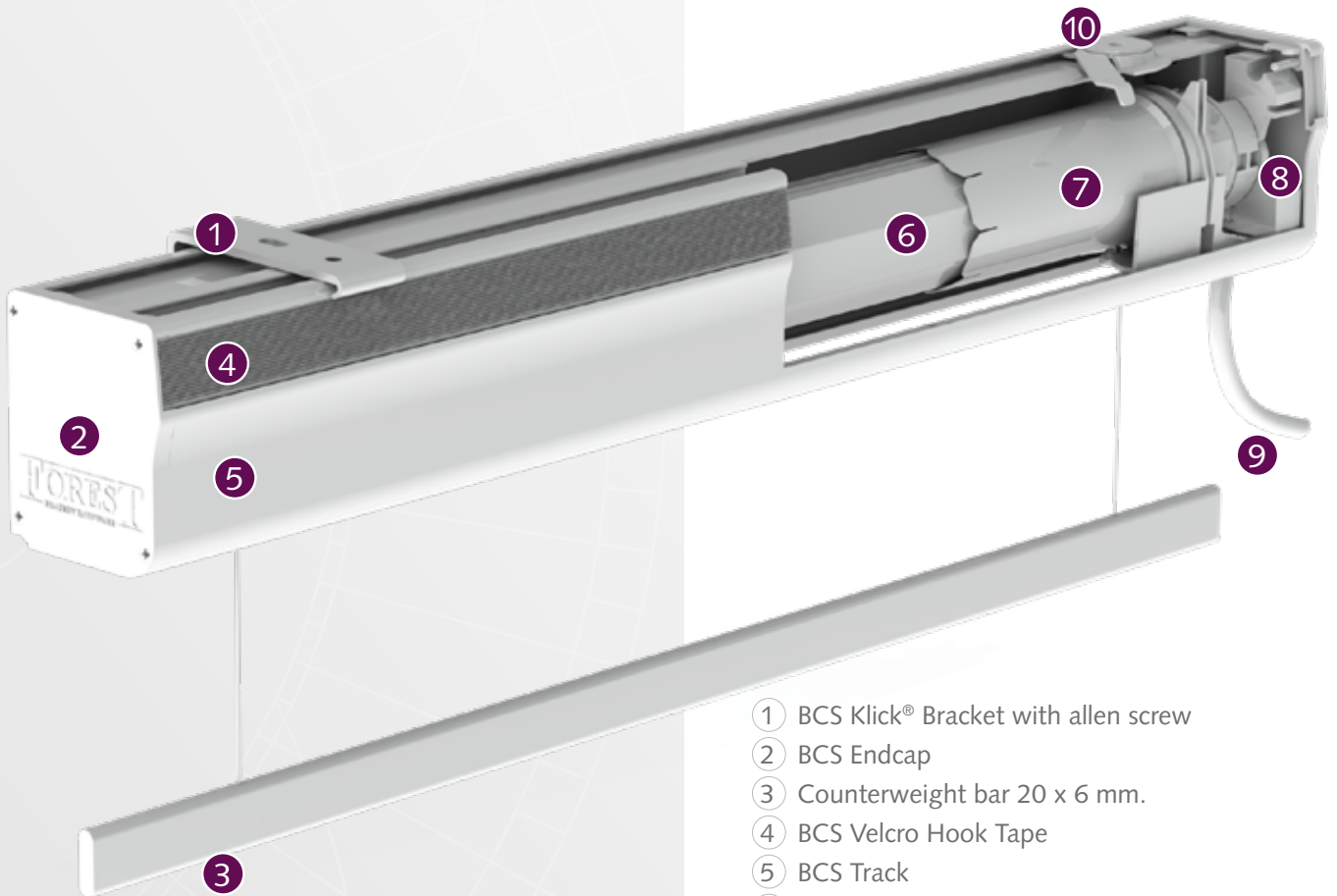
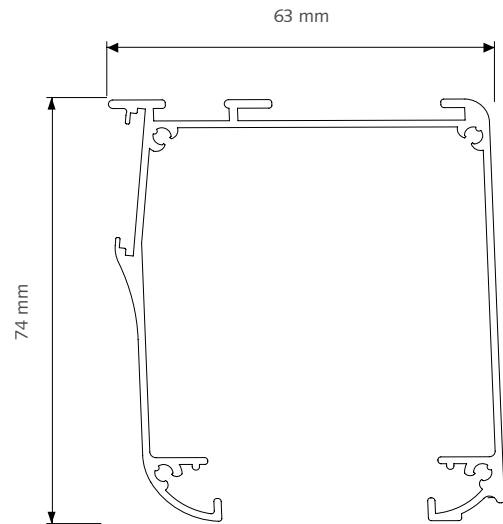

- 1 BCS Klick® Bracket with allen screw
- 2 BCS Endcap
- 3 Counterweight bar 20 x 6 mm.
- 4 BCS Velcro Hook Tape
- 5 BCS Track
- 6 BCS Tube 8-angular
- 7 BCS Cord Roll House Complete
- 8 BCS Centre Support
- 9 Forest Tubular Motor
- 10 Ceiling Swivel Bracket

FOREST BLIND CONTRACT SYSTEM - BCS®



SPECIFICATIONS

Type	Strength	Speed	Weightload	Noise level	Internal Receiver	Control options
6/28/SQ	6 Nm	28 rpm	13 kg	< 42 dB(A)	No	Home Automation / Building Automation
5/20/EQ	5 Nm	20 rpm	13 kg	< 40 dB(A)	Yes	Forest EasyTouch Series (Remote / Wireless Wall Switch)

MOUNTING

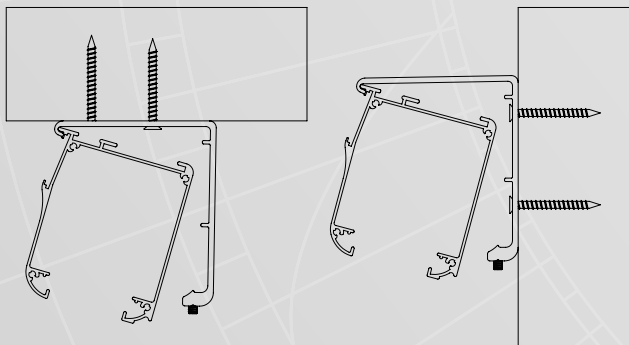

Wall and ceiling fixing is possible

ADJUSTING MOTOR

The limit settings for the tubular motors can be done as follows:

- S motors, mechanically by means of an allen key.
- E motors, electronically by means of a Forest Remote or RF Wall Switch.



CONTROL OPTIONS

Our wide range of controls make finding a fit for your home even easier; controlling the curtains by hand, remote or even by building automation system. With the remote you can control the roman blinds in any position you like. Controlling the motorised roman blind system by your smartphone or tablet, you can create and schedule customised room scenes that allow your roman blinds to operate on their own throughout the day.

REMOTE CONTROL

We offer two different remote controls and a wall switch:



- EasyTouch remote control: Operates up to 6 systems, and unused channels can be deactivated
- Diamond Sense remote control: Available as a 15- or 2-channel remote control with an LED display.
- EasyTouch wall switch: A wireless 2-channel wall switch for fixed wall-mounted operation.

All models are available in white and black.

APP CONTROL VIA FOREST WIRELESS CONNECTOR

The Forest Wireless Connector provides an easy solution to make Forest motorised roman blind systems 'smart.' When combined with a smart plug, you can effortlessly control the roman blinds through a mobile app.



Scan for more info

If you prefer to use the Forest Connect App, you can opt for Forest's smart plug. If you wish to operate your roman blinds with Apple HomeKit, Amazon Alexa, or Google Assistant, you will need a compatible third-party smart plug that works with these smart home apps. This RF device can also be seamlessly integrated into the most common building management systems, including systems with dry contacts.

The Forest Wireless Connector works only with the original RF protocol and is not compatible with the Link RF protocol.

BUILDING AUTOMATION / HOTEL CONTROL

The BCS® System can be connected to any Building Automation system, by relay control.

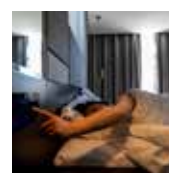

WORKS WITH



BUSCH-JAEGER

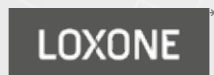

* Only works with actor.

Forest BCS® is compatible with many other Building Automation systems, thanks to its modular construction. A competitive advantage over other motorised drapery systems in the world!

ACCESSORIES

We offer a wide spectrum of captivating colours for the chains of our Roman blinds.

CHAIN COLOUR OPTIONS:



Gold



Dull Copper



Satin Nickel plated











Bright Copper

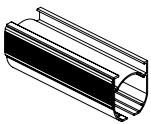



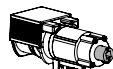
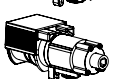

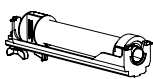
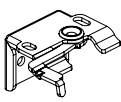
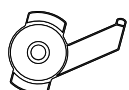
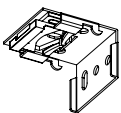
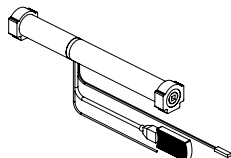

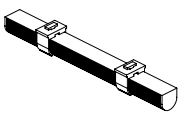
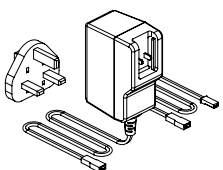

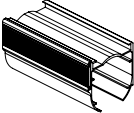
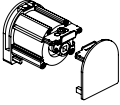
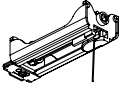
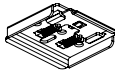
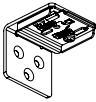
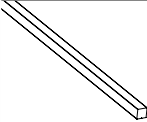

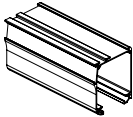
Gunmetal

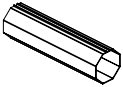
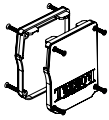
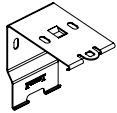
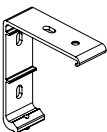

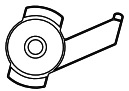
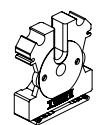
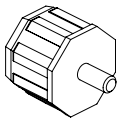
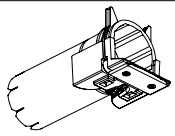
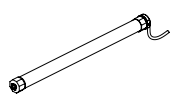
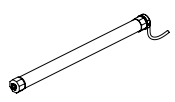

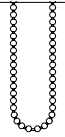
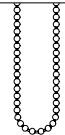

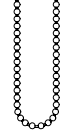



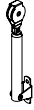

Antique Brass

BS MANUAL	BS MOTOR	BS BATTERY	BS-MAX	BCS	ARTICLE	PACKING UNIT	ART.NR	
●	●	●			 <p>BS TRACK Extruded aluminium white powder coated, with Velcro hook tape on front of the track. Available length: 5,8 mtr. (19 Ft.)</p> 	58 mtr./bundle	white	3601001580
●					 <p>BS CONTROL UNIT 1:1, incl. endcap Weight capacity 35 kg</p>  <p>BS CONTROL UNIT 1:4, incl. endcap Heavy duty, Self-braking. Operation by chain. Weight capacity 7.5 kg</p>	100/box	white	3611001011-L
●					 <p>CHILD SAFETY CONTROL UNIT 1:1 Child safe solution, incl. endcap Weight capacity 3,5 kg</p>  <p>CHILD SAFETY CONTROL UNIT 1.4 Child safe solution, incl. endcap Weight capacity 7,5 kg</p> 	100/box	white	3611001011
●	●	●			 <p>QUICKLOCK CORD ROLL incl. 3.5 mtr. cord (different color types cord available upon request, see for colour options BS/BCS Cord)</p> <p>without cord</p>	100/box	white/transparent	3642401350 3642400000
●	●	●			 <p>BS WALL BRACKET, SWIVEL Metal</p>	100/box	white	3663001000
●	●				 <p>BS CEILING BRACKET, SWIVEL</p>	100/box	white	3661000000
●	●				 <p>BS SMART CLICK WALL / CEILING BRACKET Metal</p>	100/box	white	3662000000
	●	●			 <p>BS MOTOR WITH BLUETOOTH SET Excl. Battery Pack, incl. Bluetooth Dual power options: can be cable-powered or battery-powered Features Link RF Protocol</p>  	1/set		3636000010
		●			 <p>BS MOTOR BATTERY PACK WITH USB CABLE TYPE C (3 MTR) Incl. 2 mounting brackets for on the BS Track. Incl. USB to USB-C cable</p>	1/set		3636000002
		●			 <p>BS BATTERY MOTOR 12V ADAPTOR PLUG (1.5 MTR) + EXTENSION (2.4 MTR) UK Charging set</p>	1/set		3636000005

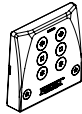
BS MANUAL	BS MOTOR	BS BATTERY	BS-MAX	BCS	ARTICLE	PACKING UNIT	ART.NR
			●		 BS MAX TRACK Extruded aluminium white powder coated, with Velcro hook tape on front of the track Available lenght: 5,8 mtr (19 Ft.)	46,4 mtr./ bundle	white 3710001580
			●		 BS MAX CONTROL UNIT 1:4 with endcap	50/box	white 3711001014
			●		 BS MAX CORD DRUM incl. 4,8 mtr. cord	50/box	white/transparent 3711000480
			●		 BS MAX HIDDEN CEILING BRACKET	50/box	white 3711000000
			●		 BS MAX L-WALL BRACKET	100/box	white 3711000001
●			●		 BS ROD 5X5 MM ALUMINIUM Aluminium 5 x5 mm (0,20" x 0,20") Available length: 5,8 mtr (19 Ft.)	10/bundle	3630000580
●			●	●	 FIBEROD 6 meter length 4mm diameter	600 mtr. / bundle	3535301600
				●	 BCS TRACK Extruded aluminium white powder coated Available Length 5,80 mtr (19 Ft.)	500 mtr./roll	white 3416101000
				●	 BCS VELCRO HOOK TAPE 25 mm height. 1,20 meter length	1/box	white 3416500004
				●	 BCS TUBE 8-ANGULAR Length 5,80 mtr (19 Ft.)	1pc	white 3416102000
				●	 BCS ENDCAPS LEFT/RIGHT	25 sets/ box	white 3416201000
				●	 BCS EASY MOUNT WALL / CEILING BRACKET For wall and ceiling fixing.	25/box	white 3416301010
				●	 BCS MOUNTING BRACKET WITH ALLEN SCREW For wall and ceiling fixing.	25/box	white 3416301020-B

BS MANUAL	BS MOTOR	BS BATTERY	BS-MAX	BCS	ARTICLE	PACKING UNIT	ART.NR
				●	 CEILING SWIVEL BRACKET For ceiling fixing.	100/box white	3818200450
				●	 BCS CENTRE SUPPORT Dimension: 51 x 56 mm.	25/box	3416500000
				●	 BCS TUBE SUPPORT 8-ANGULAR To be placed on the open end of the 8 angular tube.	25/box	3416500003
				●	 BCS CORD DRUM COMPLETE Incl. 5.5 mtr white cord.	25/box	3416500002
				●	 FOREST BMS TUBULAR MOTOR Ø 35MM 6/28/SQ For Home/ Building Automation	1/box 230v/50hz 6nm/28rpm	3416700012
				●	 FOREST LINK TUBULAR MOTOR Ø 35MM WITH INTERNAL RECEIVER 5/20/EQ For use with Forest Connect App or Forest EasyTouch Series Remote/ Wall Switch	1/box 230v/50-60hz 5nm/20 rpm/ EQ	3416700117
●			●	●	 COUNTER WEIGHT BAR 6 MTR	60 mtr./bundle 6 x 20 mm white 60 mtr./bundle 3 x 25 mm white 90 mtr./bundle 3 x 40 mm white 30 mtr./bundle 5 x 25 mm white	3501701600 3801400600 3801401600 3801402600
●			●		 ROMAN BLIND CHAIN 6 MM PITCH METAL STAINLESS STEEL Not compatible with the child safety control units	roll 150 mtr 1/bag 1.50 mtr (drop=0.75 mtr) 2.00 mtr (drop=1.00 mtr) 2.50 mtr (drop=1.25 mtr) 3.00 mtr (drop=1.50 mtr) 3.50 mtr (drop=1.75 mtr) 4.00 mtr (drop=2.00 mtr) 4.50 mtr (drop=2.25 mtr)	3670008100 3670008150 3670008200 3670008250 3670008300 3670008350 3670008400 3670008450
●			●		 ROMAN BLIND CHAIN 6 MM PITCH METAL Not compatible with the child safety control units	roll 150 mtr 1/bag 1.50 mtr (drop=0.75 mtr) 2.00 mtr (drop=1.00 mtr) 2.50 mtr (drop=1.25 mtr) 3.00 mtr (drop=1.50 mtr) 3.50 mtr (drop=1.75 mtr) 4.00 mtr (drop=2.00 mtr) 4.50 mtr (drop=2.25 mtr) 5.00 mtr (drop=2.50 mtr) 6.00 mtr (drop=3.00 mtr)	3670003100 3670007150 3670007200 3670007250 3670007300 3670007350 3670007400 3670007450 3670007500 3670007600
●			●		 ROMAN BLIND CHAIN 6 MM PITCH METAL MATT BLACK Not compatible with the child safety control units	roll 1.00 mtr	3670006100
●			●		 BS ENDLESS CHAIN 6 MM PITCH WHITE Compatible with the child safety control units	1/bag 1.00 mtr (drop=0,50 mtr) 1.50 mtr (drop=0.75 mtr) 2.00 mtr (drop=1.00 mtr) 2.50 mtr (drop=1.25 mtr) 3.00 mtr (drop=1.50 mtr) 3.50 mtr (drop=1.75 mtr) 4.00 mtr (drop=2.00 mtr) 4.50 mtr (drop=2.25 mtr) 5.00 mtr (drop=2.50 mtr) 6.00 mtr (drop=3.00 mtr)	3670002100 3670002150 3670002200 3670002250 3670002300 3670002350 3670002400 3670002450 3670002500 3670002600
●			●		 CHAIN JOINTING PLIER For joining two ends of the metal chain together	1/box	3675900001

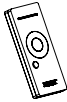
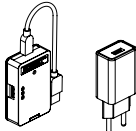
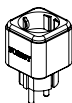
BS MANUAL	BS MOTOR	BS BATTERY	BS-MAX	BCS	ARTICLE	PACKING UNIT	ART.NR
●			●		 CORD/CHAIN WALL MOUNT SAFETY BOX SINGLE	25/box	3645702000
●			●		 TENSION PULLEY	25/box white	1030501000
●			●		 CORD/CHAIN WEIGHT DESIGN	10/box white grey black	3030701000 3030703000 3030706000
●			●	●	 LOOP TAPE 20MM To be fixed onto the curtain fabric	25 mtr./roll	3816202020
●			●	●	 ROMAN BLIND CORD For use in combination with Cord Roll Support / Cord Drum. Thickness: 1.3 mm.	500 mtr/roll white (other colours available upon request: white, corn, grey, off-white, black, steel grey, old pink, mocca, beige, moss, salmon, aubergine, green, pink)	3645001000
●			●	●	 SNAP CORD FIXER For easy adjustment of the bottom side of the blind	100/box transparent	3647001001
●			●	●	 SNAP CORD FIXER CHILD SAFETY	100/box transparent	3611001001
	●			●	 FOREST EASYTOUCH WIRELESS WALL SWITCH 2 channel LED Equipped with the original RF protocol and Forest Link® Dimensions : 8.3 x 8.3 x 1.9 cm	1/box white black	5201001480 5201006480
	●			●	 FOREST EASYTOUCH REMOTE CONTROL 6-channel Equipped with the original RF protocol & Forest Link® protocol Excl. Wall holder	1/box matt white matt black	5201081006 5201086006
	●			●	 FOREST EASYTOUCH WALL HOLDER Only suitable for EasyTouch remote control	1/box transparent	5201080000
	●			●	 FOREST DIAMOND SENSE REMOTE CONTROL 2-15 channel with LED display Integrated timer included,original RF Protocol Incl. magnetic wall holder	1/box white black	5201091470 5201086470
		●			 BS MOTOR BATTERY REMOTE 6-CHANNEL Inclusive magnetic wall mount	1/set	3636000003
	●			●	 FOREST WIRELESS CONNECTOR Incl.15 cm USB cable. Always in combination with USB-adaptor. Can be ordered separately as Forest Wireless Connector USB-adaptor. One way transmitter to integrate system in Domotic System. To control by third apps like Google Home, Amazon Alexa or Apple Homekit use a (third-party) smart plug. Works only with original RF Protocol and not Link RF protocol	1/box white USB adapter EU USB adapter UK USB adapter AU USB adapter US	5201002270 5201002271-EU 5201002271-UK 5201002272-AU 5201002274-US
	●			●	 SMART PLUG WHITE The Smart Plug allows App control via the Forest Connect App (the Forest Wireless Connector is required)		Upon request

BR0016EN060326UK