

FOREST KS® SERIES



MANUAL
CONTROL



RECESS
OPTION



EASY
TO BEND

Highly efficient hand drawn system for all types of medium and light weight draperies.
Quick installation with “Smart Klick” brackets for wall and ceiling applications.

FOREST KS®
FOREST KS® RECESS



THE WORLD
BEHIND
YOUR
CURTAINS

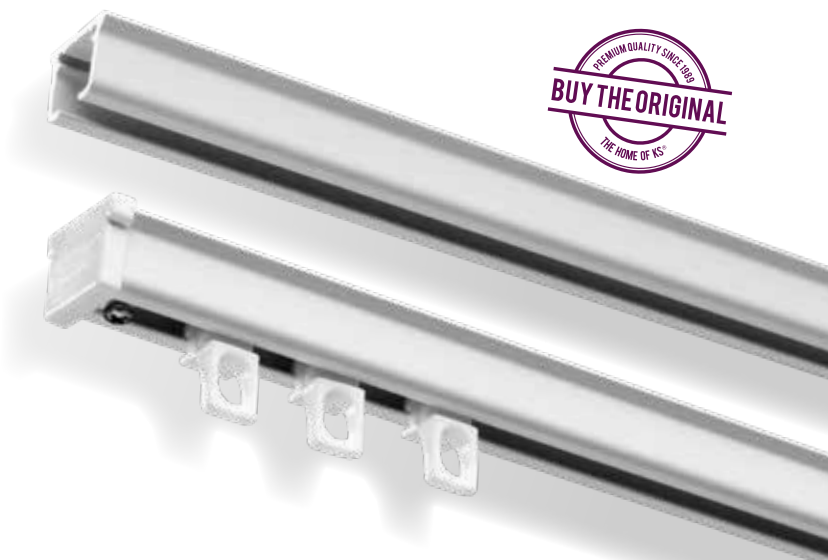



PRODUCT INFORMATION

- Highly efficient hand drawn system for all types of medium weight draperies.
- Quick installation with “Smart Klick” brackets for wall and ceiling applications with cover caps that conceal the screws.
- Bendable; it can be bent and reversed bent using a 10 cm (4”) radius or continuous curve.
- Suitable for special window decoration as circular, arch and triangle window models.
- Heavy duty clickable carriers, UV-protected, for smooth and easy traversing.
- Offset shape for straight hanging pleats.
- Can also be used for Forest Easyfold System and accordiafold drapery systems.
- Maximum fabric weight: 8 kg per meter (6 LBS per ft.).
- Colours available: white, gold, grey, brown, black, cream & beige.
- Special colours: available on request.
- Available lengths: 3 meter (9’10”), 4 meter (13’1”), 5 meter (16’4”), 6 meter (19’8”), 7 meter (23’).
- Track finish: High quality aluminium, powder coated with a factory applied patented dry lubricant.

FEATURES

- Scale: Shown actual size 1:1
- Weight: 150 grams per meter (1.62 ounce per ft.)
- Material: Aluminium Extrusion
- Dimensions: 14 mm x 20 mm (0,6” x 0,8”)
- KS Recess: 12.5 mm x 21 mm (0,5” x 0,8”)

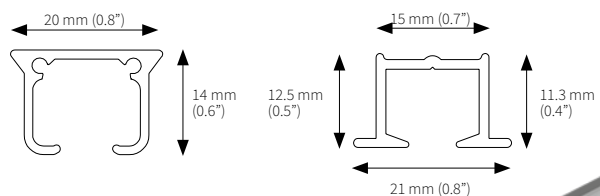

- 1 KS track
- 2 Carrier
- 3 Stop Carrier
- 4 Twist End Stop
- 5 Twist End Stop with cap

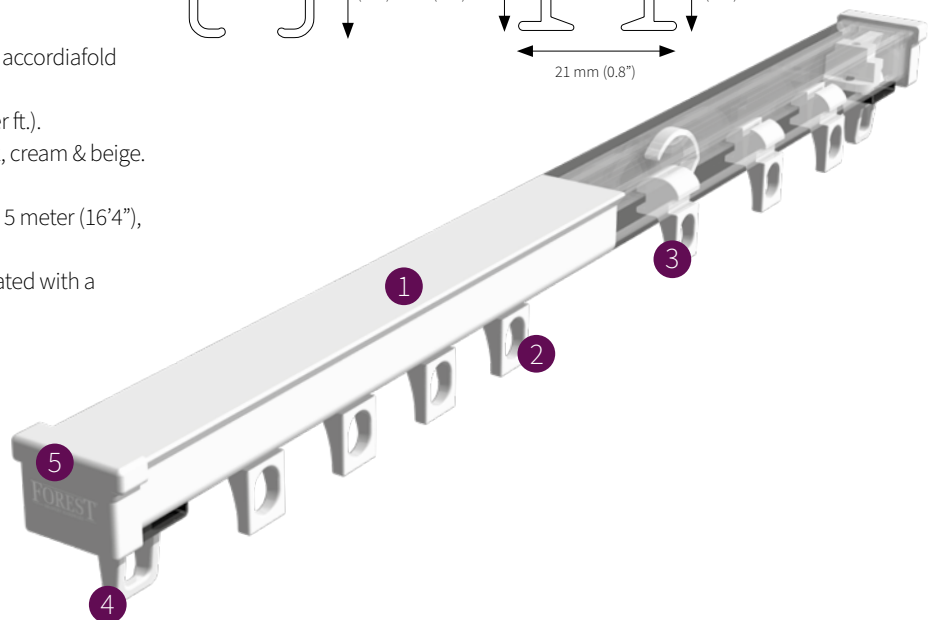



COLOUR OPTIONS

White Gold Grey Brown Black Cream Beige

SPECIAL WINDOW DECORATION

Special bends

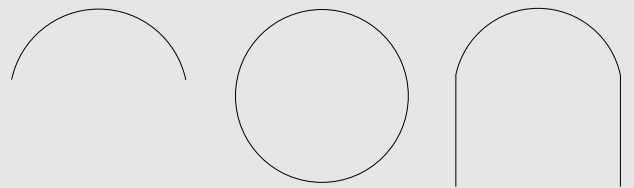

FOR USE IN

Hotels - offices - schools - healthcare - residences - boats - campers - planes or at any location where an efficient hand drawn system is required.

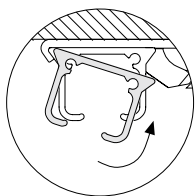

Easy installation
click - position - tighten

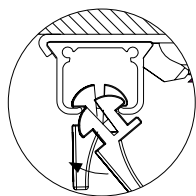

clickable carrier

25 mm (1")

BENDING / CURVING

The track can be curved and reversed curved using a 10 cm (4") radius. Additionally there is a curving possibility for special windows like arches, bows and circles. Bending instructions available on request.



APPLICATIONS

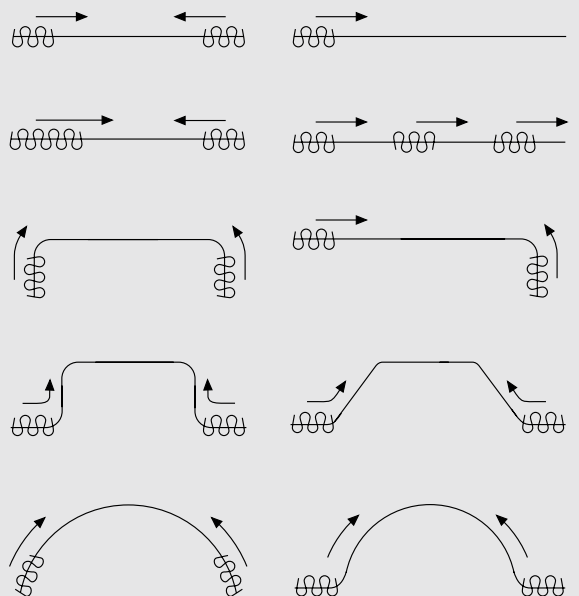

MOUNTING BRACKETS

Wall bracket

3.5 cm (1.4")

6 cm (2.4")

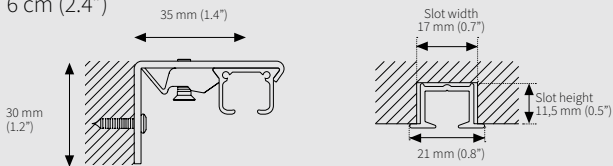

Milling dimensions
KS Recess

A) Min. 10 cm (4")



A) Min. 16 cm (6")

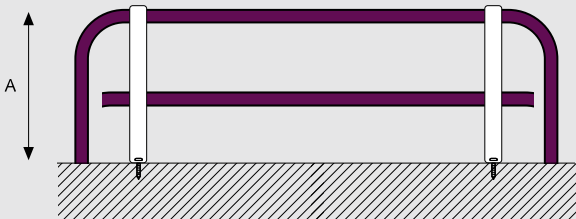

Other brackets are available. Brackets need to be placed every 60 cm (24").

Smart Click Ceiling Bracket

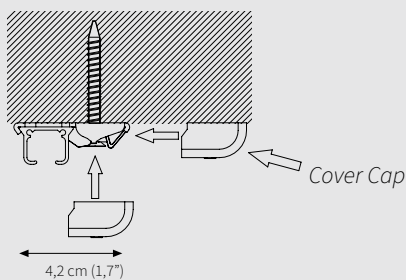

Aluminium Wall bracket single

A) 7.5 cm (3")

B) 6.3 cm (2.5")

A) 10 cm (4")

B) 8.8 cm (3.5")

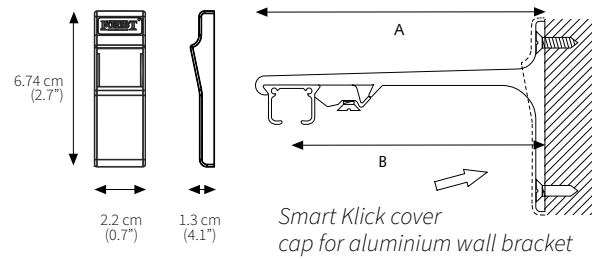

Smart Klick cover
cap for aluminium wall bracket

Aluminium Wall bracket double

A) 15 cm (6")

B) 9.2 cm (3.6")

C) 4.5 cm (1.8")

A) 20 cm (8")

B) 9.2 cm (3.6")

C) 9.5 cm (3.7")

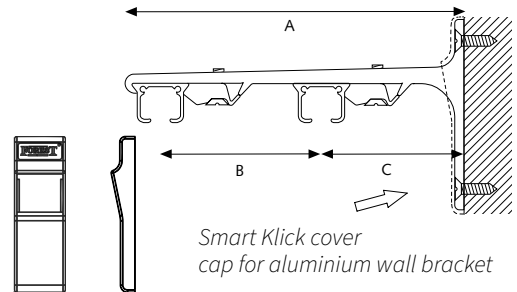

Smart Klick cover
cap for aluminium wall bracket

Aluminium Wall bracket triple

A) 25 cm (10")

B) 9.3 cm (3.7")

C) 5 cm (2")

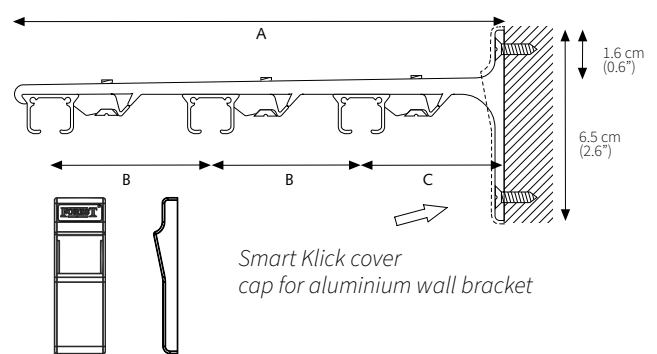

Smart Klick cover
cap for aluminium wall bracket









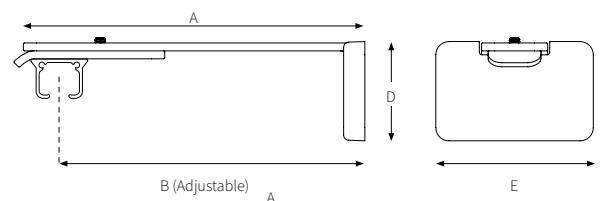

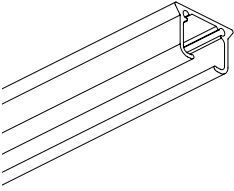
CRS Adjustable Wall Bracket

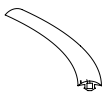

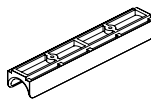
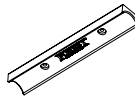
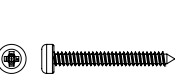







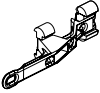
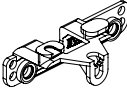
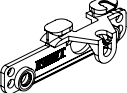

8 cm (3,1"), adjustable to 9,5 cm (3,7").

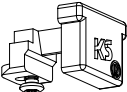
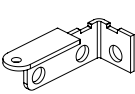

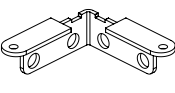



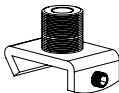
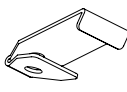



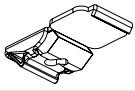
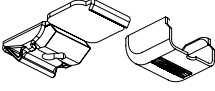
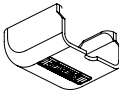
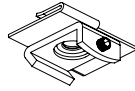
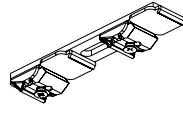

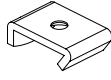
A = 8,9 (3,5") / B = 8 (3,1") < 9,5 (3,7") /

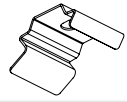
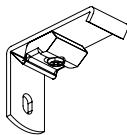

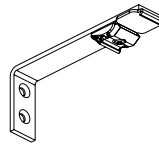
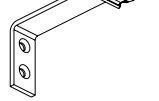

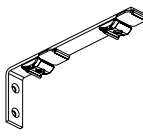

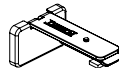

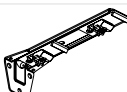

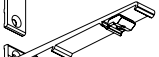

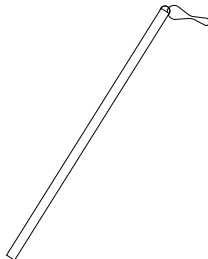
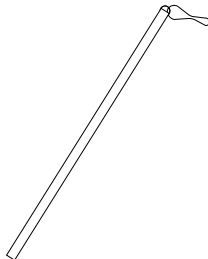
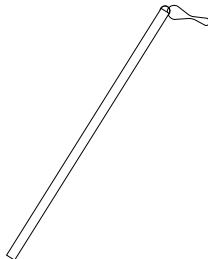
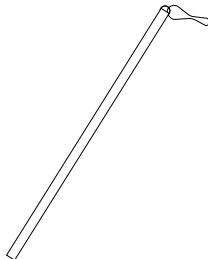
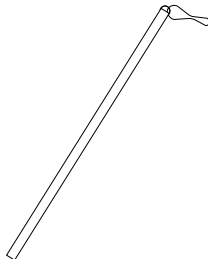
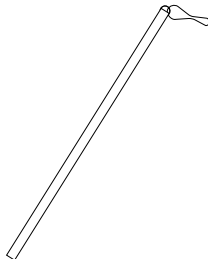
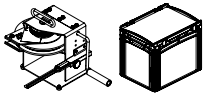

D = 3,75 (1,5") / E = 5,95 cm (2,3")

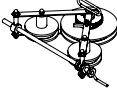

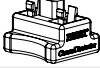
KS	KS RECESS	ARTICLE	PACKING UNIT	ART.NR		
●			KS TRACK WHITE Aluminium extrusion, powder coated, lubricated.	60 mtr/bundle 80 mtr/bundle 100 mtr/bundle 120 mtr/bundle 140 mtr/bundle	3 mtr (9'8") 4 mtr (13'1") 5 mtr (16'4") 6 mtr (19'8") 7 mtr (23')	1001001300 1001001400 1001001500 1001001600 1001001700
			KS TRACK GREY Aluminium extrusion, powder coated, lubricated.	120 mtr/bundle 140 mtr/bundle	6 mtr (19'8") 7 mtr (23')	1001003600 1001003700
			KS TRACK GOLD Aluminium extrusion, powder coated, lubricated.	120 mtr/bundle	6 mtr (19'8")	1001002600
			KS TRACK BROWN Aluminium extrusion, powder coated, lubricated.	120 mtr/bundle	6 mtr (19'8")	1001005600
			KS TRACK BLACK Aluminium extrusion, powder coated, lubricated.	100 mtr/bundle 120 mtr/bundle 140 mtr/bundle	5 mtr (16'4") 6 mtr (19'8") 7 mtr (23')	1001006500 1001006600 1001006700
			KS TRACK MORE COLOUR OPTIONS Aluminium extrusion, powder coated, lubricated. off-white sand	100 mtr/bundle	5 mtr (16'4") 5 mtr (16'4")	1001011500 1001012500
	●		KS RECESS TRACK 6 Mtr (19'8") Aluminium extrusion, powder coated, lubricated and pre-drilled.	6 mtr/bundle	white matt white black matt black	1031011600 1031011600-M 1031016600 1031016600-M
	●		MTS FLEXIBLE DUST STRIP. To seal the curtain track opening of the ks recess track during finishing phase.	50 mtr/roll		4518501000
●			KS TRACK CONNECTORPIN STAINLESS 2X20 MM For a firm and seamless connection between two pieces of KS track.	10/box		9900000012
●			KS/DS/CKS TRACK CONNECTOR	10/box	white grey black	1018401010 1018403010 1018406010
●			KS PLASTIC TRACK CONNECTOR Can be inserted in the track, but still allows the carrier to run over.	50/box		1018400000
	●		KS RECESS INTERNAL CONNECTOR	50/box		1030000001
	●		MOUNTING SET FOR INTERNAL TRACK CONNECTOR (set consists 200 screws & 2 drill bits)	1/set		8880000001
	●		SCREW M3 X 25MM FOR KS RECESS PROFILE STAINLESS STEEL	250/box		Forest073
●	●		KS AS CARRIER "Klickable", offset, constructed of UV-resistant plastic. 10 Carriers on a break-away strip. Can be clicked in after installation.	500/box	white grey brown black	1010001000 1010003000 1010005000 1010006000
●	●		KS SYMMETRICAL CARRIER	500/box	white	1010101000
●			KS STOPCARRIER Prevents slide back, "klickable", constructed of UV-resistant plastic. Not in combination with KS plastic track connector & KS recess connector.	250/box	white grey black	1010201000 1010203000 1010206000
●	●		KS SHIRRTAPE CARRIER Carrier and hook in one "klickable" unit, constructed of UV-resistant plastic. For sew on drapery tape.	500/box	white grey black	1010401000 1010403000 1010406000

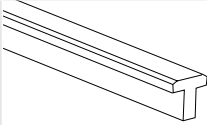
KS	KS RECESS	ARTICLE	PACKING UNIT		ART.NR
•		 MASTER CARRIER/REVERSIBLE Reversible overlap carrier, "Klicks" into track, constructed of UV-resistant plastic. For straight track only. Colours: 01.	25/box		1010301000
•	•	 EASYFOLD PLASTIC MASTER UNDERLAP The Plastic Master is reversible. There are also snaps on the back of the Master.	25/box	white transparent grey black	4815201010 4815201000 4815203010 4815206010
•	•	 EASYFOLD PLASTIC MASTER STRAIGHT The Plastic Master is reversible. There are also snaps on the back of the Master.	25/box	white transparent grey black	4815101010 4815101000 4815103010 4815106010
•	•	 KS TWIST ENDSTOP "Twists" into track, with metal plate, constructed of UV-resistant plastic.	100/box	white grey black	1016201000 1016203000 1016206000
•		 KS TWIST ENDSTOP WITH CAP "Twists" into track, with metal plate and end cap, constructed of UV-resistant plastic. Suitable for standard pleat.	100/box	white grey black	1016301000 1016303000 1016306000
	•	 KS RECESS PUNCH ENDSTOP To cover the slot Suitable for various carriers, such as those used for standard and wave pleat.	100/box	white black	1060601000 1060606000
•		 KS ENDCAP + SCREW SHORT For use with single draw curtains; carriers can run through to the end of the track. Install the cover cap on the operating side. For the stack back side, use the KS End Cap with screw. Suitable for standard and wave pleat. Made of UV-resistant plastic.	100/box	white grey black	1006001000 1006003000 1006006000
•		 EASYFOLD KS UNIVERSAL ENDCAP WITH SCREW To be screwed with a Wave carrier, made of UV-resistant plastic. Install the cover cap on both sides. Suitable for standard pleat and wave pleat.	100/box	white grey brown black	4816001000-A 4816003000-A 4816005000 4816006000-A
•		 KS WALL SUPPORT RIGHT 2,5 x 5 cm (1"x2") return plate, powder coated.	25/box	white grey	1016601000 1016603000
		 KS WALL SUPPORT LEFT 2,5 x 5 cm (1"x2") return plate, powder coated.		white grey	1016701000 1016703000
•		 STRAIGHT RETURN R/L 5 x 5 cm (2 x 2") reversible return plate, powder coated.	25/box	white brown	1016501000 1016505000
•		 MTS SUSPENSION CEILING BRACKET INCL TUBE Ceiling Bracket for KS. To be used in combination with the Suspension Ceiling Bracket. Length: 10 cm (4") - 100 cm (40") Complete with MTS Insert Screw and MTS Top Piece	1/each	white	4518201000
		 MTS SUSPENSION CEILING BRACKET 1,50 MTR WHITE Length: 100 cm (40") - 150 cm (59") Complete with MTS insert screw and MTS Top Piece	1/each	white black	4518201500 4518206150
		 MTS SUSPENSION CEILING BRACKET 2,00 MTR WHITE Length: 200 cm (78") Complete with MTS insert screw and MTS Top Piece	1/each	white	4518202000
•		 SUSPENSION BRACKET CLIP FOR KS For KS, to be used in combination with the MTS Suspension Ceiling Bracket.	50/box	white black	1016901000 1016906000
•		 KS CEILING BRACKET Slides onto the track, powder coated. Regular duty.	100/box	white grey brown black	1018001000 1018003000 1018005000 1018006000
•		 KS CEILING BRACKET WITH SLOT Slides onto the track, powder coated. Regular duty.	100/box	white grey brown black	1018101000 1018103000 1018105000 1018106000

KS	KS RECESS	ARTICLE	PACKING UNIT		ART.NR
•		 KS SMART KLICK CEILING BRACKET "Klicks" onto track, powder coated.	100/box	white grey black	1018201000 1018203000 1018206000
•		 KS SMART KLICK CEILING BRACKET INCL COVER CAP "Klicks" onto track, powder coated.	100/box	white grey anthracite black	1018201001 1018203001 1018204001 1018206001
•		 KS SMART KLICK COVER CAP Fits on Smart Klick Wall and Ceiling bracket.	100/box	white grey brown black	1019201000 1019203000 1019205000 1019206000
•		 FALSE CEILING BRACKET (METAL) For installation on to a suspended ceiling. The track can be fixed in any angle.	25/box	white black	4519001000 4519006000
•		 KS SMART KLICK CEILING BRACKET DOUBLE LONG Distance between two tracks: 90 mm (3,5")	30/box	white grey black	1018601000 1018603000 1018606000
		 KS SMART KLICK CEILING BRACKET DOUBLE SHORT Distance between two tracks: 60 mm			1018611000
•		 FSS MOUNTING BRACKET For concealed installation or ceiling installation in narrow spaces. Heavy Duty.	100/box		7160001000
•		 KS CEILING SPLICE BRACKET For ceiling installation only, powder coated.	50/box	white black	1018501000 1018506000
•		 KS KLICK-ON CEILING BRACKET WHITE For concealed installation without visible brackets, light weight use only. Use with countersunk screw 3x25mm	100/box	wit grey black	1018301000 1018303000 1018306000
•		 KS SK WALL BRACKET 3,5 cm "Klicks" onto track, powder coated. One screw attachment.	50/box	white grey black	1020201035 1020203035 1020206035
		 KS SK WALL BRACKET 6 cm "Klicks" onto track, powder coated. One screw attachment.		white grey black	1020201060 1020203060 1020206060
•		 KS SK WALL BRACKET 7,5 cm	30/box	white grey black	1020201075 1020203075 1020206075
		 KS SK WALL BRACKET 10 cm	20/box	white grey black	1020201100 1020203100 1020206100
		 KS SK WALL BRACKET 12,5 cm	20/box	white grey	1020201125 1020203125
		KS SK WALL BRACKET 15 cm	15/box	white grey black	1020201150 1020203150 1020206150
		KS SK WALL BRACKET 20 cm	15/box	white	1020201200
		KS SK WALL BRACKET 25 cm	10/box	white	1020201250
		KS SK WALL BRACKET 30 cm	10/box	white	1020201300
•		 KS SMART KLICK WALL BRACKET DOUBLE 10 cm	15/box	white	1020601100
		 KS SMART KLICK WALL BRACKET DOUBLE 15 cm	15/box	white	1020601150
		KS SMART KLICK WALL BRACKET DOUBLE 20 cm	15/box	white	1020601200
•		 KS ADJUSTABLE WALL BRACKET 8 CM INCL. COVER	2/box	white matt white grey matt black	1020901080 1020901080-M 1020903080 1020906080-M
•		 KS ADJUSTABLE SMART KLICK WALL BRACKET, SINGLE 7.5 CM - 11.5 CM	100/box	white	1020801115
•		 KS ADJUSTABLE SMART KLICK WALL BRACKET, DOUBLE 6.5 CM - 19.5 CM	50/box	white	1020801195

KS	KS RECESS	ARTICLE	PACKING UNIT	ART.NR		
●		    	KS SMART KLICK ALUMINIUM WALL BRACKET 7,5 cm	20/box	white grey brown black	1020301075 1020303075 1020305075 1020306075
			KS SMART KLICK ALUMINIUM WALL BRACKET 10 cm	20/box	white grey black	1020301100 1020303100 1020306100
			KS SMART KLICK ALUMINIUM WALL BRACKET 15 cm	15/box	white grey brown black	1020301150 1020303150 1020305150 1020306150
			KS SMART KLICK ALUMINIUM WALL BRACKET 20 cm	15/box	white grey black	1020301200 1020303200 1020306200
			KS SMART KLICK ALUMINIUM WALL BRACKET 25 cm	10/box	white grey	1020301250 1020303250
●			COVER CAP FOR KS SMART KLICK ALUMINIUM WALL BRACKET	50/box	white grey black	1021301000 1021303000 1021306000
●	●	     	KS FLICKSTICK FIBERGLASS	50/box	92 cm 122 cm 152 cm	1065101092 1065101122 1065101152
			KS FLICKSTICK TRANSPARENT	50/box	92 cm 122 cm 152 cm	1065102092 1065102122 1065102152
			KS FLICKSTICK WHITE ALUMINIUM	50/box	92 cm 122 cm 152 cm	1065111092 1065111122 1065111152
			KS FLICKSTICK Grey ALUMINIUM	50/box	92 cm 122 cm 152 cm 202 cm	1065111202 1065113092 1065113122 1065113152
			KS FLICKSTICK BLACK ALUMINIUM	50/box	92 cm 152 cm	1065116092 1065116152
			KS FLICKSTICK ANTIQUE ALUMINIUM	50/box	92 cm 122 cm 152 cm	1065119092 1065119122 1065119152
			●	●		KS/DS BENDING HOUSE COMPACT ALL-IN Includes lubricant spray, angle finder and bending case. Excludes bending wheel and strips.
●	●		KS BENDING WHEEL SET ALL-IN incl. strips + wedges KS RECESS BENDING WHEEL ALL-IN incl. strips + wedges	1/each 1/each		1050100000 1030000000
●	●		KS/DS BENDING CASE Box for storing all bending components of the KS/CKS system. Dimensions: 40x30x33.5 cm. Box excludes all components.	1/each		1050000001
●			CONTINUOUS CURVER Add on tool for the Compact Bending Tool. Designed to create continuous curves and arches in any radius. Includes KS bending strip. For KS and CKS Track only.	1/each		1060200000
●	●		ELECTRIC POWERED BENDER Available in 230V or 115V To create continuous curves and arches minimum radius 50 cm (20")	1/each		1060500000
●	●		CHANNEL PROTECTOR with bit	1/set	purple	1070600000
	●		KS RECESS PUNCH PINCHER	1/each		1060600000
●	●		KS BENDING STRIP For Compact Bending Tool.	1/each		1060100000
			KS RECESS BENDING STRIP Length of strip: 60 cm (23,6"). 2 strips	1/each 2/each		8500000000-A 1030000000-D
			FOR CONTINUOUS CURVER/ELECTRIC BENDER. KS Length of strip: 7 mtr. (23'). KS RECESS Length of strip: 7 mtr. (23').	1/each 1/each		1060300000 8500000010
●	●		KS/CKS BENDING WHEELS - For Electric Powered Bender. Complete set of 3 wheels. KS RECESS BENDING WHEELS - For Electric Powered Bender. Complete set of 3 wheels.	1/set 1/set		1060700000 1030700000
●	●		ELECTRIC POWERED RAILCUTTER 230 Volt EU	1/each		1061100000
			BLADE FOREST CUTTER NEW MODEL	1/each		1061200001
●			TABLE DISPLAY KS-DS-DS-DS-XL	1/each		9902100002