





-  Hey Google
-  Hey Siri
-  Hey Alexa



**DOMOTICA**  
READY



**APP**  
CONTROL



**WIRELESS**  
REMOTE



**CORDED**  
CONTROL



**MANUAL**  
CONTROL

## FOREST DESIGN Series

The DS-XL® Series is designed to create visual impact and provides superior functionality and ease of use to the end-user. Available as manual, corded or motorised operated curtain track system.

- FOREST DS®
- FOREST DS-XL®
- FOREST DS-XL® Motorised
- FOREST DS-XL® LED
- FOREST DS-XL® LED Motorised

THE WORLD  
BEHIND  
YOUR  
CURTAINS



reddot winner 2021

# FOREST DS® - DESIGN SYSTEM



The DS® curtain track system is for fans of a sleek curtain track. This manually operated curtain track system fits into any stylish interior with an eye for design.

The DS® system has the same core dimension as the Klick System (KS®). This makes it possible to use all KS® assembly components (except the end caps).

The height of the track is 11 mm, and the curved elevation of the profile has an ergonomically designed extension to it so that the brackets can be mounted out of sight. Giving you a clean almost recess finish to your system when being utilised in a ceiling fix scenario.

## PRODUCT INFORMATION

- Elegant and aesthetically pleasing hand drawn track system.
- For all types of medium weight draperies (max. curtain weight 8kg per meter).
- Colours available: matt white, white, grey, taupe, antique, anthracite, matt black, black.
- Available lengths in white: 4, 5, 6 & 7 meter (grey, taupe, antique, anthracite, black in 6 meter and matt white, matt black in 6 and 7 meter).
- Bendable, designer curtain track can be bent and reverse bent to a tight 10cm radius, or continuously curved using a 50cm radius.
- Matching assembly components for white, grey and black.
- Invisible ceiling brackets to fix track flush to ceiling available.
- Quick installation with "Smart Klick" brackets for wall and ceiling applications.
- Same brackets as used with Klick System.
- Heavy duty clickable carriers - UV protected - for smooth and easy traversing.
- Especially designed for use in combination with Forest Easyfold System for wave pleat application.
- Track finish: powder coating with a factory applied patented dry lubricant.
- Warranty: 10 years.

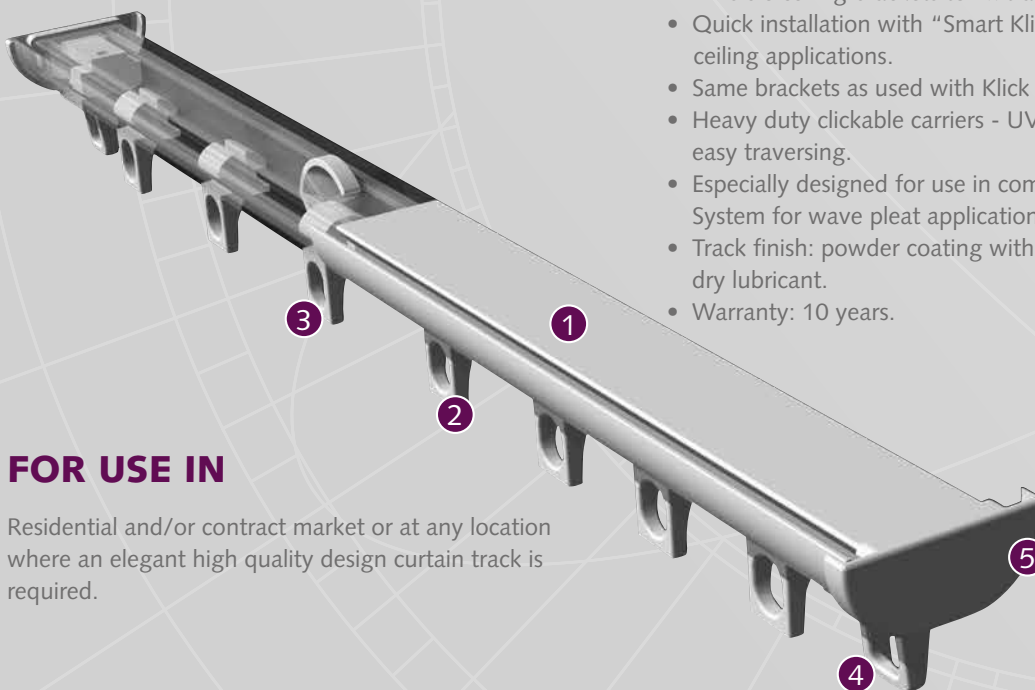

- 1 DS Track
- 2 DS Carrier
- 3 DS Stop carrier
- 4 DS Twist end stop
- 5 DS End cap

## FOR USE IN

Residential and/or contract market or at any location where an elegant high quality design curtain track is required.



## SPECIFICATIONS

- Shown actual size 1:1
- Weight: 170 gr/meter
- Aluminium Extrusion
- Size: 12 x 24 mm (0.5" x 0.9")
- Colours: white, matt-white, grey, anthracite, black, matt-black

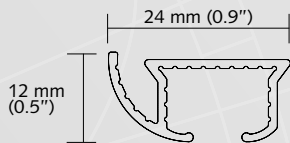

## BENDING / CURVING

The track can be bent and reverse bent using a 10cm radius. Continuous curving is available by special order from the factory only.



## APPLICATIONS

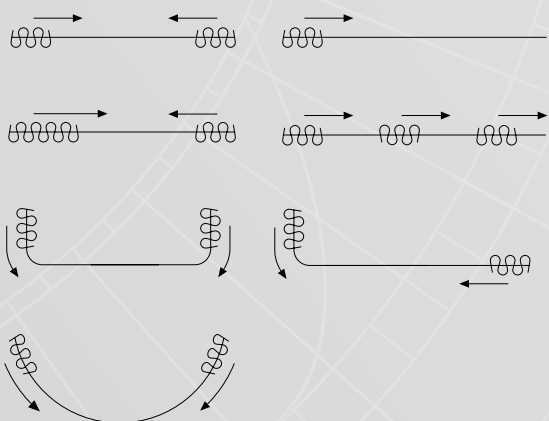

## MOUNTING

### Smart Klick Aluminium wall bracket single

- A) 7,5 cm      B) 6,3 cm
- A) 10 cm      B) 8,8 cm

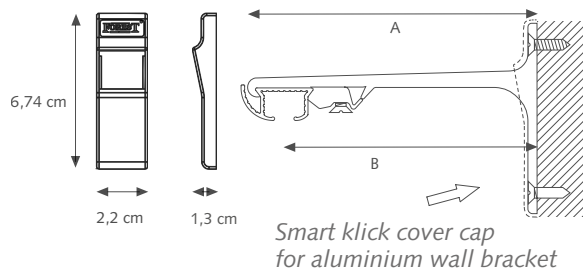

### Smart Klick Aluminium wall bracket double

- A) 15 cm      B) 9,2 cm      C) 4,5 cm
- A) 20 cm      B) 9,2 cm      C) 9,5 cm

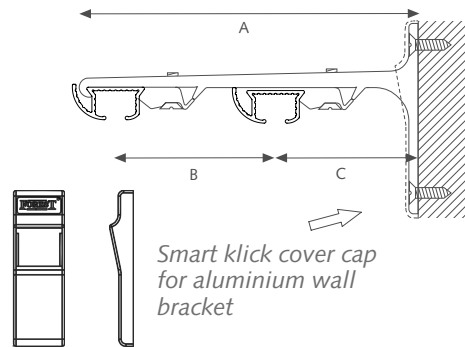

### Smart Klick Aluminium wall bracket triple

- A) 25 cm      B) 9,3 cm      C) 5 cm

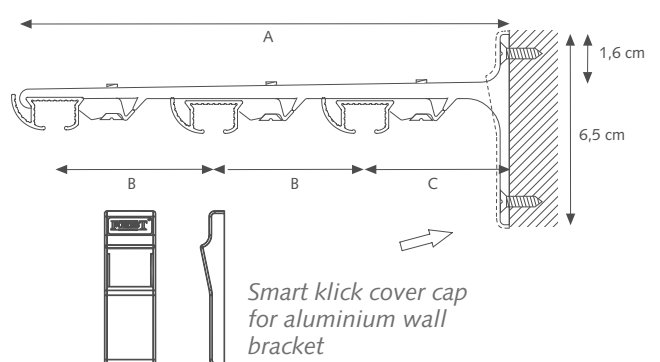

### Adjustable Wall Bracket

- 8 cm (3,1") adjustable to 9,5 cm (3,7").
- A = 8,9 (3,5") / B = 8 (3,1") < > 9,5 (3,7") / D = 3,75 (1,5") / E = 5,95 cm (2,3")

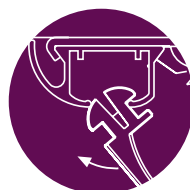
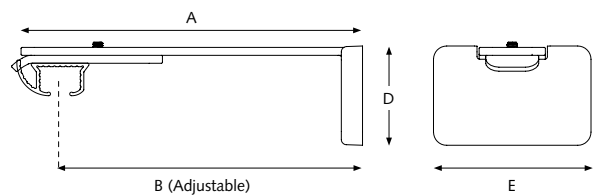

Clickable carrier



Clickable bracket

# FOREST DS-XL®



With the DS-XL® Series, Forest offers curtain tracks that optimally combines design and functionality. The Design System XL gives every interior an extra visual appearance.

Stylish curtains deserve an elegant and fashionable curtain track. The DS-XL® Series provide a sleek finish and contribute to a unique design look at home or in any hotelroom.

Thanks to a symmetrical profile, the system can be mounted "blind" to the ceiling. This provides an extra sleek finish. The track is easy to mount by means of swivel supports or click supports.

The DS-XL® track system has been especially designed for use with our wave system, Forest Easyfold System. But it is also suitable with regular pleated curtain headings.

## FOR USE IN

Hotels, offices, residences, boats, campers, planes or anywhere an efficient and elegant track system is required for curtains and drapes.

## PRODUCT INFORMATION

- Elegant and aesthetical hand drawn and corded curtain track system.
- For all types of medium weight draperies.
- Quick and easy installation.
- Ceiling brackets and wall brackets available.
- Invisible ceiling brackets to fix track flush to ceiling available.
- Heavy duty carriers - uv protected - for smooth and easy traversing.
- Colours available: white, grey or anthracite with matching assembly components.
- Available length: standard stock size 6 meter (19.8").
- Especially designed for use in combination with our wave pleat system 'Forest Easyfold System' .
- Warranty: 10 years.

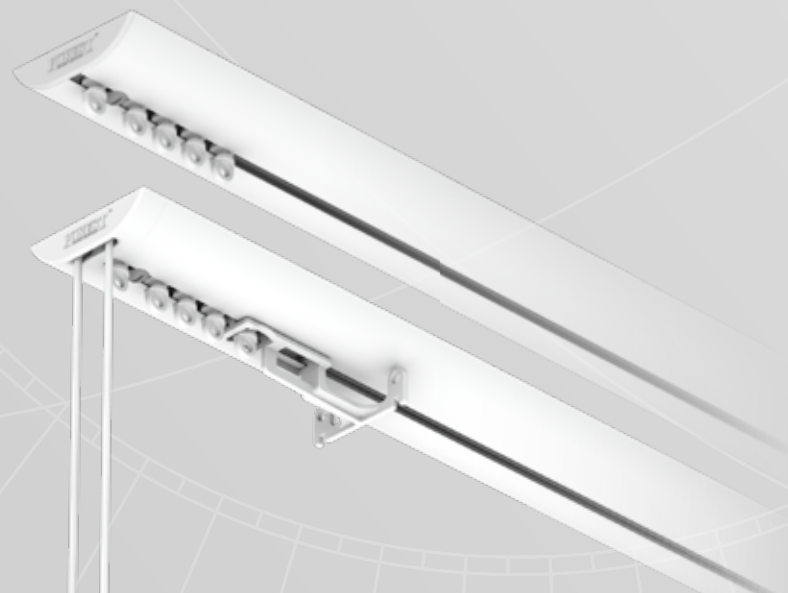

## PROFILE

- Shown actual size 1:1
- Weight: 480 gr/meter
- Aluminium extrusion
- Size: 60 x 15 mm
- Colours: white, grey, anthracite

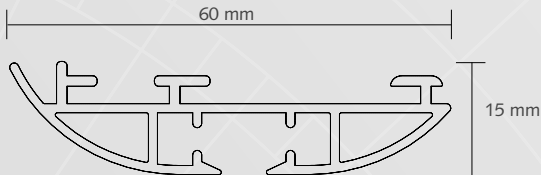

## FOREST EASYFOLD SYSTEM

The forest wave series are an Additional feature of the drapery Hardware systems of forest group. It complies fully with the Contemporary demand for Round and fluent shapes in Decorative interiors.

It offers new possibilities for Applications in large and High spaces, such as lobbies, entrees, reception areas, conference rooms, auditoriums, meeting rooms, Food and beverage outlets etc.

The system can be installed onto all forest manual, corded (except cks) and Motorised tracks and curtain rod systems and gives a modern and special folding design to the curtain.

Such a modern curtain heading system Combined with a suitable fabric is Guaranteed to be a real eye-catcher In every room.

## EASYFLEX/EASYWAVE TOOL

With this tool you will be able to easily calculate your requirements of Easyflex carriers and Easyflex tape to obtain a beautiful folding curtain. Please scan the QR-code.



## COLOUR OPTIONS

DS-XL® is available in three colours: white, grey and anthracite.



# FOREST DS-XL® LED / Motorised



reddot winner

This unique drapery system combines a stylish design with a unique way of lighting. Many designers will work with a lighting plan with three levels: High, especially if the ceiling is vaulted or has been finished with a special material; medium, which includes wall sconces; and low, which means floor lamps and other small lights. Our DS-XL® LED is the solution for a lighting plan on a higher level, integrating our track to create an overall glow on the ceiling.

The DS-XL® LED is an elegant system for all types of medium weight draperies. Available length up to 6 meter in 2 colours: timeless white and in a stylish anthracite finish, making it suitable to fit in every design.

## Create privacy

It also offers the possibility to illuminate the backside and/or the curtain track itself enabling a higher level of privacy.

## SUSTAINABLE LIGHTING

Traditional ways of lighting are very wasteful. Most of the power is wasted in the form of heat. This is why there has been a big push to change the environmental impact of lighting. Another benefit of LED lighting is sustainability and eco-friendliness. The system doesn't use toxic chemicals and it can last for years. It has a life span of approximately 30.000 hours.

## PRODUCT INFORMATION

- Hand drawn or motorised curtain track system
- Designer track for lighting and curtain track combined.
- Colours available: white and anthracite.
- Especially designed for Forest Wave application.
- Simple electrical installation by means of clickable connectors.
- Ceiling brackets and wall brackets available.
- Supplied with 1 LED strip.
- LED Colour temperature: warm white 3000.
- Low energy consuming LED strip, eco friendly.
- Dimmable LED strips (120 LED's per meter).
- LED lifespan of 30.000 hours.
- No soldering, clickable components for easy installation without the need for an electrician.
- Power: 10 watt/mtr.
- Energy label A+.
- The DS-XL® LED Motorised system can be integrated into any building automation system.
- The DS-XL® LED motorised track system is advised to be used with a Forest Shuttle® L motor.
- Warranty: 10 years (LED-lighting 2 years).



## DS-XL® LED MOTORISED

The Forest DS-XL® Series is also available with an LED variant: the DS-XL LED. This innovative curtain rail system is not only a visual highlight in any space due to its integrated lighting but also offers ultimate ease of use. The system can be easily controlled via a remote, app, or home automation system, creating an unparalleled experience of comfort and ambiance. Additionally, you can choose between one or two LED strips for the perfect atmosphere.



## RED DOT AWARD

The DS-XL® LED Motorised track system has been awarded for the Red Dot Award 2021 for its outstanding product design. The Red Dot Award is one of the most internationally known and sought-after awards in the design industry.



reddot winner

## SPECIFICATIONS

- Shown actual size 1:1
- Size LED 61 x 20 mm
- Size LED Motorised 61 x 25 mm
- Weight LED 580 gr/meter
- Weight LED Motorised 675 gr/meter
- Aluminium extrusion

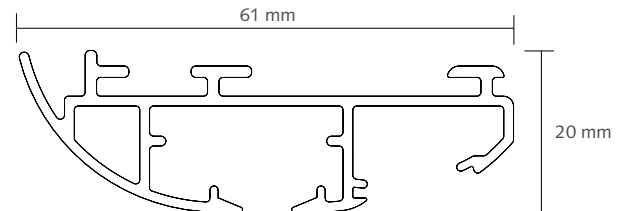

Manual  
DS-XL LED  
Colours: white & anthracite

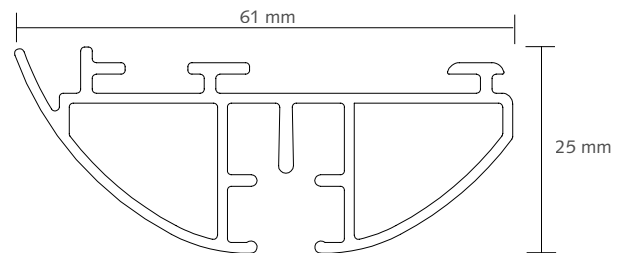

Motorised  
DS-XL  
Colours: matt white & matt black

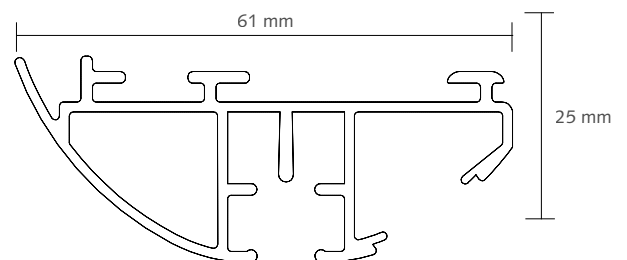

Motorised  
DS-XL LED  
Colours: white & anthracite

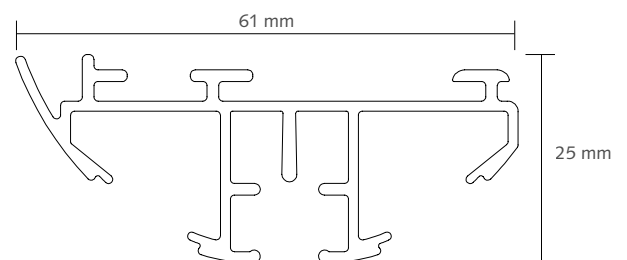

Motorised  
DS-XL Double LED  
Colours: white & matt black

# FOREST DS-XL® LED Control Options

Our wide range of controls make finding a fit for your home even easier; controlling the curtains by hand, remote or even by building automation system. With the remote you can control the curtains in any position you like. Controlling the motorised curtain system by your smartphone or tablet, you can create and schedule customised room scenes that allow your curtains to operate on their own throughout the day.



## REMOTE CONTROL

We offer two different remote controls and a wall switch. These are available in white and black.

- EasyTouch remote control. Operates up to 6 systems, and unused channels can be deactivated.
- Diamond Sense remote control. A 15- or 2-channel remote with an LED display.
- EasyTouch wall switch. A wireless 2-channel wall switch for fixed wall-mounted operation.

## APP CONTROL VIA FOREST WIFI-DONGLE

With the Shuttle® Wi-Fi dongle, you can control your motorised curtains with your mobile device by the Forest Connect app or even by voice command with the easy integration in for example Google Home or Amazon Echo without the need for an additional hub or gateway.

## APP CONTROL VIA FOREST WIRELESS CONNECTOR

With the Forest Wireless Connector, you can easily make your motorised Forest system smart.

In combination with a smart plug, you can effortlessly control your Forest system using the Forest Connect App or any other smart home app.

Control one or multiple Forest Systems – simultaneously or individually – via an app, whether you're at home or away.

Want to control your Forest system via Apple HomeKit, Amazon Alexa, or Google Assistant? Then you'll need a compatible third-party smart plug that works with those systems.

The Wireless Connector is an RF device that also integrates seamlessly with most common building management systems, including systems with dry contacts.

## BUILDING AUTOMATION / HOTEL CONTROL

The DS-XL® System can be connected to any Building Automation system, by relay control.



Scan for more info

## SMART DEVICE CONNECTIVITY



Configure the right motorised curtain track system in a few steps.

	Shuttle M/L	Shuttle M/L with Z-Wave	Shuttle iOn	Shuttle AC	Shuttle Go	Forest Connect app	Google Home	Apple Homekit	Amazon Alexa	Google Assistant	Apple Siri	Voice control
Forest Wireless Connector One way transmitter to control curtains by third party apps or by Domotics. (433Mhz)	●		●			● <sup>1</sup>	● <sup>1</sup>	● <sup>2</sup>	● <sup>1</sup>	● <sup>1</sup>	● <sup>1</sup>	● <sup>1</sup>
Forest Wi-Fi Dongle in combination with Forest Connect app	●	●			● <sup>5</sup>	●	●		●	●	●	
Smartwares Controller in combination with HomeWizard lite app (433 Mhz)	●		●						●			
Homey in combination with Homey app	●	●	●		●		●	●	●	●	●	
FIBARO System in combination with FIBARO Home Center app		●		● <sup>3</sup>			●	●	●	●	●	
Samsung SmartThings Hub in combination with Samsung SmartThings app		●					●	●	●	●	●	
230 Volt hard-wired building management system	● <sup>4</sup>			●								











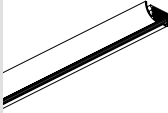
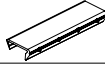



- 1) In combination with Forest smart plug
- 2) In combination with Apple Homekit smart plug
- 3) Only with FIBARO Roller Shutter 3 / Walli Roller Shutter
- 4) In combination with an AC Control Set
- 5) Wi-Fi is included in Shuttle Go. No Wi-Fi Dongle needed to add in the Forest Connect App



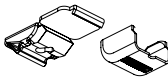

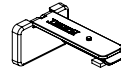

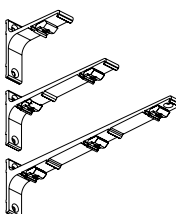
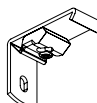



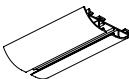
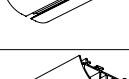
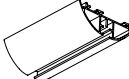
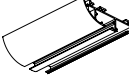
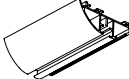
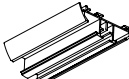





## FOREST SHUTTLE® WORKS WITH

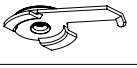

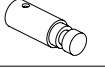



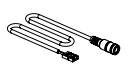



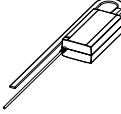
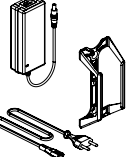





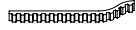

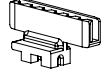
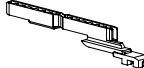

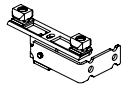
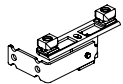
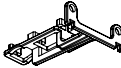
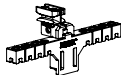
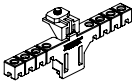
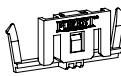



\* Only works with actor.





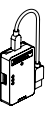

Forest DS-XL® (LED) is compatible with many other Building Automation systems, thanks to its modular construction. A competitive advantage over other motorised drapery systems in the world!

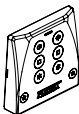
DS	DS-XL	DS-XL CORDED	DS-XL MOTORISED	DS-XL LED	DS-XL LED MOTORISED	DS TRACK + COMPONENTS	ARTICLE	PACKING UNIT		ART.NR
●							DS TRACK MATT WHITE	120 mtr/bundle	6 mtr	2001001600-M
								140 mtr/bundle	7 mtr	2001001700-M
							DS TRACK WHITE	80 mtr/bundle	4 mtr	2001001400-G
								100 mtr/bundle	5 mtr	2001001500-G
								120 mtr/bundle	6 mtr	2001001600-G
								140 mtr/bundle	7 mtr	2001001700-G
							DS TRACK GREY	120 mtr/bundle	6 mtr	2001003600-G
							DS TRACK TAUPE	120 mtr/bundle	6 mtr	2001004600-G
							DS TRACK ANTIQUE	120 mtr/bundle	6 mtr	2001009600-G
							DS TRACK ANTHRACITE	120 mtr/bundle	6 mtr	2001005600-G
DS TRACK BLACK	120 mtr/bundle	6 mtr	2001006600-G							
							DS TRACK MATT BLACK	120 mtr/bundle	6 mtr	2001006600-M
								140 mtr/bundle	7 mtr	2001006700-M
●							TRACK CONNECTOR For use of DS / KS / CKS	10/box	white grey black	1018401010 1018403010 1018406010
●							INTERNAL DS PLASTIC TRACK CONNECTOR Can be inserted in the track, but still allows the carrier to run over.	50/box	white	2018400000-G
●							CARRIER ASYMMETRICAL Clickable, UV-resistant plastic, 10 carriers on a breakaway strip. (also symmetrical carriers available).	500/box	white grey black	1010001000 1010003000 1010006000
●							CARRIER SYMMETRICAL	500/box	white	1010101000
●							STOP CARRIER Clickable, UV-resistant plastic	250/box	white grey black	2010201000 2010203000 2010206000
●							DS TWIST ENDSTOP WITH CAP UV-resistant plastic with metal plate. "Twists" into track	100/box	white grey black	2016301000 2016303000 2016306000
●							DS ENDCAP SHORT + SCREW for one-way draw curtains	100/box	white grey anthracite black	2006001000 2006003000 2006005000 2006006000
●							DS ENDCAP UNIVERSAL + SCREW	100/box	white grey anthracite black	4816101000 4816103000 4816105000 4816106000
●							CEILING BRACKET Slides onto the track, powder coated. Regular duty	100/box	white grey black	1018001000 1018003000 1018006000
●							CEILING BRACKET WITH SLOT Slides onto the track, powder coated. Regular duty Slotted support makes fixing curtain track easier	100/box	white grey black	1018101000 1018103000 1018106000
●							SMART KLICK CEILING BRACKET Powder coated, "klicks" onto track. Attach with VK-4 mm screw.	100/box	white grey black white grey anthracite black	1018201000 1018203000 1018206000 1018201001 1018203001 1018204001 1018206001
							SMART KLICK CEILING BRACKET INCL. COVER CAP		white grey anthracite black	1019201000 1019203000 1019204000 1019206000
●							COVER CAP FOR SMART KLICK BRACKETS Suitable for Smart Klick Wall-and Ceiling brackets		white grey anthracite black	1019201000 1019203000 1019204000 1019206000
●							FALSE CEILING BRACKET (METAL) For installation on to a suspended ceiling. The track can be fixed in any angle.	25/box	white	4519001000
●							ADJUSTABLE WALL BRACKET 8 CM INCL. COVER	2/box	white matt white grey matt black	1020901080 1020901080-M 1020903080 1020906080-M
●							SMART KLICK WALL BRACKET 3,5 cm Klicks onto track, powder coated. One screw attachment. For light weight use only.	50/box	white grey black	1020201035 1020203035 1020206035
							SMART KLICK WALL BRACKET 6 cm Klicks onto track, powder coated. One screw attachment. For light weight use only.		white grey black	1020201060 1020203060 1020206060
							SMART KLICK WALL BRACKET 7,5 cm Klicks onto track, powder coated. One screw attachment. For light weight use only.		white grey black	1020201075 1020203075 1020206075
●							ALUMINIUM SK WALL BRACKET 7,5 CM SINGLE Klicks onto track, powder coated.	20/box	white grey black	1020301075 1020303075 1020306075
							ALUMINIUM SK WALL BRACKET 10 cm SINGLE Klicks onto track, powder coated.	20/box	white grey black	1020301100 1020303100 1020306100
							ALUMINIUM SK WALL BRACKET 15 cm DOUBLE Klicks onto track, powder coated.	15/box	white grey black	1020301150 1020303150 1020306150
							KS ALUMINIUM SK WALL BRACKET 20 cm DOUBLE Klicks onto track, powder coated.	15/box	white grey black	1020301200 1020303200 1020306200
							ALUMINIUM SK WALL BRACKET 25 cm TRIPLE Klicks onto track, powder coated.	10/box	white grey black	1020301250 1020303250 1020305250
●							SMART KLICK COVER CAP ALUMINIUM BRACKET UNIVERSAL	50/box	white grey black	1021301000 1021303000 1021306000

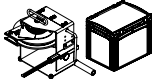
DS	DS-XL	DS-XL CORDED	DS-XL MOTORISED	DS-XL LED	DS-XL LED MOTORISED	DS-XL/ DS-XL LED/ DS-XL (LED) MOTORISED + COMPONENTS	ARTICLE	PACKING UNIT	ART.NR	
	●	●					DS-XL TRACK MANUAL/CORDED, 6 mtr	24mtr/ bundle	white grey anthracite	3916101600 3916103600 3916105600
							DS-XL TRACK MANUAL/CORDED, 4 mtr		white anthracite	5917501400 5917506400
			●				DS-XL TRACK MOTORISED, 6 mtr	6mtr/bundle	matt white matt black	5942001600-MAT 5942006600-MAT
				●			DS-XL LED TRACK MANUAL	6mtr/length	white anthracite	5917501600 5917505600
					●		DS-XL LED TRACK MOTORISED, 6 mtr. In combination with Shuttle L motor & the Shuttle M adaptor	6mtr/length	white anthracite	5915501600 5915505600
					●		DS-XL DOUBLE LED MOTORISED TRACK, 6 mtr. In combination with Shuttle L motor & the Shuttle M adaptor	6mtr/length	white matt black	5941001600 5941006600
	●	●	●	●	●		ECONOMY CARRIER SMALL	500/box	white grey black	3910101000 3910103000 3910106000
●			●		●		ENDSTOP UNIVERSAL METAL	100/box	matt white grey matt black	8880001000 8880003000 8880006000
	●	●		●			DS-XL ENDSTOP To use in combination with adjustable wave carrier Easyflex. For center draw curtains	100/box	white grey black	3916001000 3916003000 3916006000
	●						DS-XL ENDCAP	20/box	white grey black	3916101000 3916103000 3916106000
		●					DS-XL ENDCAP CORDED metal	20/box	white grey anthracite	3916201001-ZA 3916203001-ZA 3916205001-ZA
				●			DS-XL LED ENDCAP	20/box	white black	5916501000 5916506000
				●			DS-XL LED END CAP FLAT	20/box	white black	5916501002 5916506002
	●	●	●	●	●		DS-XL KLICK CEILING BRACKET	100/box		3918301000
	●	●	●	●	●		DS-XL CEILING SWIVEL BRACKET	100/box	white anthracite	3818200230 3818205230
	●	●	●	●	●		WALL BRACKET 9 CM	5/box	white anthracite	3820001018 3820005018
	●	●	●	●	●		WALL BRACKET EXTENSION 4 CM	10/box	white anthracite	5815201030 5815205030-PC
	●	●	●	●	●		DS-XL TRACK CONNECTOR STRAIGHT	10/box		3916401000
	●			●			DS-XL TRACK CONNECTOR 90°	10/box		3916401001
				●	●		DS-XL LED STRIP 3000K/ 24V/ 10W/m 8mm width	50mtr/roll		5917503055
				●	●		DS-XL LED STRIP CONNECTOR CABLE FOR DIMMER, EXTENSION CABLE 35 cm / 24Vdc 35 cm / 24Vdc 200cm / 24Vdc 200cm / 24Vdc	1/piece	white black white black	5917502431-A 5917502432-A 5917502421-A 5917512422-A
				●	●		DS-XL LED-STRIP CONNECTOR CABLE FOR ADAPTOR 200cm / 24Vdc 200cm / 24Vdc 35 cm / 24Vdc 35 cm / 24Vdc	1/piece	white black white black	5917502521 5917502522 5917502531 5917502532
				●	●		DS-XL LED RF DIMMER In combination with Shuttle M adaptor To control LED light via Forest remote/wall switch	1/box	white black	5917531470 5917536470

DS	DS-XL	DS-XL CORDED	DS-XL MOTORISED	DS-XL LED	DS-XL LED MOTORISED	DS-XL/ DS-XL LED/ DS-XL (LED) MOTORISED + COMPONENTS	ARTICLE	PACKING UNIT	ART.NR	
				●	●		DS-XL LED WIFI DIMMER In combination with Shuttle M adaptor To control LED light via Forest Connect App	1/box	white black	5917541000 5917546000
				●	●		ADAPTOR SET SHUTTLE M - FOR EU, UK AND USA (icm DS-XL LED Dimmer) Incl. cable & holder EU 0.50 mtr EU 3.00 mtr UK 0.50 mtr USA 0.50 mtr EU 0.50 mtr	1/box	white white white white black	5201002002 5201002003 5201002004 5201002007 5201006002
				●	●		ADAPTOR SET SHUTTLE M - FOR AUSTRALIA Items to be ordered separately FOREST ADAPTOR 24 VOLT DC (UNIVERSAL, EXCL CABLE) WALL BRACKET FOR POWER SUPPLY 5201002000 POWER CABLE FOR SHUTTLE L & S AUS 1.80 mtr	1/box 1/box 1/box	white	5201002000 5201002001 5201001141
					●		SPLITTER CABLE 1XC8/2XC7 50 CM With the splitter cable, only one power outlet is needed to power both the Shuttle motor and the DS-XL LED RF Dimmer/DS-XL LED Wifi Dimmer	1/box	white black	5205911050 5205916050
				●	●		SWITCHING POWER SUPPLY DC EXTENSION CABLE for Shuttle S/M power supply in combination with DS-XL LED Dimmer	1/box	2 meter /white	5209002200
			●				DS-XL LED STRIP ANTHRACITE To cover the LED-channel when not in use	6mtr/bundle	anthracite	5916505000
				●	●		DS-XL LED STRIP MOUNTING DEVICE	1/box		5916509999
			●		●		DS-XL (LED) MOTOR/RETURN PULLEY SET METAL	1/box	matt white matt black anthracite	5917011001-SET 5917015001-SET 5917015000-SET
			●		●		FMS TRANSPORT BELT Toothed belt, to be installed inside the FMS Track	100mtr/roll		5105501000
			●		●		FMS BELT CONNECTOR Connects the Master Carrier with the transport belt	50/box	white grey black	5103011500 5103013500 5103016500
			●		●		WAVE BELT CONNECTOR CENTER DRAW For use with wave pleat curtains (Easyflex) To use in combination with adjustable wave carrier	50/box	white grey black	4813001040 4813003040 4813006040
			●		●		WAVE BELT CONNECTOR ONE-WAY DRAW For use with wave pleat curtains (Easyflex) To use in combination with adjustable wave carrier	50/box	white grey black	4813001030 4813003030 4813006030
DS	DS-XL	DS-XL CORDED	DS-XL MOTORISED	DS-XL LED	DS-XL LED MOTORISED	FOREST WAVE COMPONENTS	ARTICLE	PACKING UNIT	ART.NR	
●							WAVE DS ENDCAP + SCREW To be screwed with an Easywave carrier, made of UV-resistant plastic for wave	100/box	white grey black	4816101000 4816103000 4816106000
			●		●		EASYFLEX MASTER CARRIER 90 DEGREE LEFT for center draw in combination with master carrier right 90° left for small stiffener	25/box	white grey black white	4815351090 4815353090 4815356090 4815361090
			●		●		EASYFLEX MASTER CARRIER 90 DEGREE RIGHT for center draw in combination with master carrier left 90° right for small stiffener	15/box	white grey black white	4815451090 4815453090 4815456090 4815461090
	●	●		●			EASYFLEX PLASTIC MASTER CARRIER 90 DEGREE	15/box	white black	3916701000 3916703000 3916706000
					●		WAVE ADJUSTABLE MASTER CARRIER For use with wave pleat curtains (Easyflex). Height adjustable and blocks detachable for the correct wave pleat depth.	25/box	white black	4813001050 4813006050
●	●	●	●	●	●		WAVE ADJUSTABLE ENDSTOP For use with wave pleat curtains (FES). Height adjustable and blocks detachable for the correct wave pleat depth. For DS-XL (LED) motorised, only suitable with a metal return pulley.	25/box	white black	4816001001 4816006001
			●		●		WAVE ADJUSTABLE HOOK FOR MOTOR For use with wave pleat curtains (Easyflex). For DS-XL (LED) motorised, only suitable with a metal return pulley.	25/box	white black	4813001010 4813006010

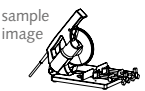
DS	DS-XL	DS-XL CORDED	DS-XL MOTORISED	DS-XL LED	DS-XL LED MOTORISED	CONTROL COMPONENTS + OTHER ITEMS	ARTICLE	PACKING UNIT	ART.NR
		●					DS-XL CORD CONNECTOR	100/box	white black 3916301000 3916306000
		●					TRAVERSE CORD - Polyester drapery cord designed for strong smooth slide, Ø 3.5 mm (0,14"), 16 ply. Suitable for CKS/CCS/CRS/DS-XL Corded	250 mtr/roll	white grey black 1030401000 1030403000 1030406000
		●					TENSION PULLEY	25/box	white 1030501000
		●					CORD/CHAIN WALL MOUNT SAFETY BOX SINGLE	25/box	3645702000
		●					CORD/CHAIN WEIGHT DESIGN 110 GR WIT	10/box	white grey black 3030701000 3030703000 3030706000
			●	●	●		FOREST EASYTOUCH REMOTE CONTROL 6-channel. Equipped with the original RF protocol and Forest Link® protocol. Excl. Wall holder. Works with all Shuttle motors	1/box	matt white matt black 5201081006 5201086006
			●	●	●		FOREST EASYTOUCH WALL HOLDER Only suitable for EasyTouch remote control	1/box	transparent 5201080000
			●	●	●		FOREST DIAMOND SENSE REMOTE CONTROL Works only with original RF protocol	1/box	white black 5201091470 5201096470
			●		●		FOREST WIFI DONGLE Incl. cable. WiFi 2.4GHz. Bidirectioneel Power supply 12V DC 300mA max USB power 5V DC 1000mA max Control the curtains with Forest Connect App	1/box	white black 5201002280 5201006280
			●		●		FOREST WIRELESS CONNECTOR Incl. 15 cm USB cable. Always in combination with USB-adaptor. Can be ordered separately as Forest Wireless Connector USB-adaptor. One way transmitter to control curtains by third party apps (i.e Google/Apple /Amazon) or by Domotics	1/box	white 5201002270
			●		●		FOREST WIRELESS CONNECTOR USB-ADAPTOR	1/box	EU UK AU US 5201002271-EU 5201002271-UK 5201002272-AU 5201002274-US
			●		●		FOREST EASYTOUCH WIRELESS WALL SWITCH 2 channel LED Dual protocol: Original RF & Forest Link® Dimensions: 8.3 x 8.3 x 1.9 cm	1/box	white black 5201001480 5201006480

						BENDING COMPONENTS	ARTICLE	PACKING UNIT	ART.NR
●							KS/DS BENDING HOUSE COMPACT ALL-IN Includes lubricant spray, angle finder and bending case. Excludes bending wheel and strips. DS BENDING WHEEL ALL-IN incl. strips (60cm)	1/piece	1050000000 2050000000
							KS/DS BENDING CASE Box for storing all bending components of the DS system. Dimensions: 40x30x33.5 cm. Box excludes all components.	1/piece	1050000001
							ELECTRIC POWERED BENDER For creating continuous curves. Minimum radius 50 cm.	1/box	230V 110V 1060500000 1060500001
							DS BENDING WHEELS Set of 3 bending wheels for electric powered bender. Only suitable for DS track.	1/set	2060700000
							DS T-BENDING STRIP SET ELECTRIC For DS electric powered bender, Length of 60 cm.	1/piece	7m 8500000000
	●	●	●				ELECTRIC POWERED RAILCUTTER - 230 Volt EU	1/piece	1061100000
							BLADE FOREST CUTTER NEW MODEL	1/piece	1061200001
	●	●					TABLE DISPLAY KS-DS-DS-XL	1/piece	9902100002