

TECHNICAL SPECIFICATION:

- 12V battery type 27A
- battery life < 3 years
- frequency 433.92MHz
- transmit power max. 10mW
- transmit range indoor max. 30mtr
- working temperature -10°C - +50°C
- each channel can control up to 20 receivers

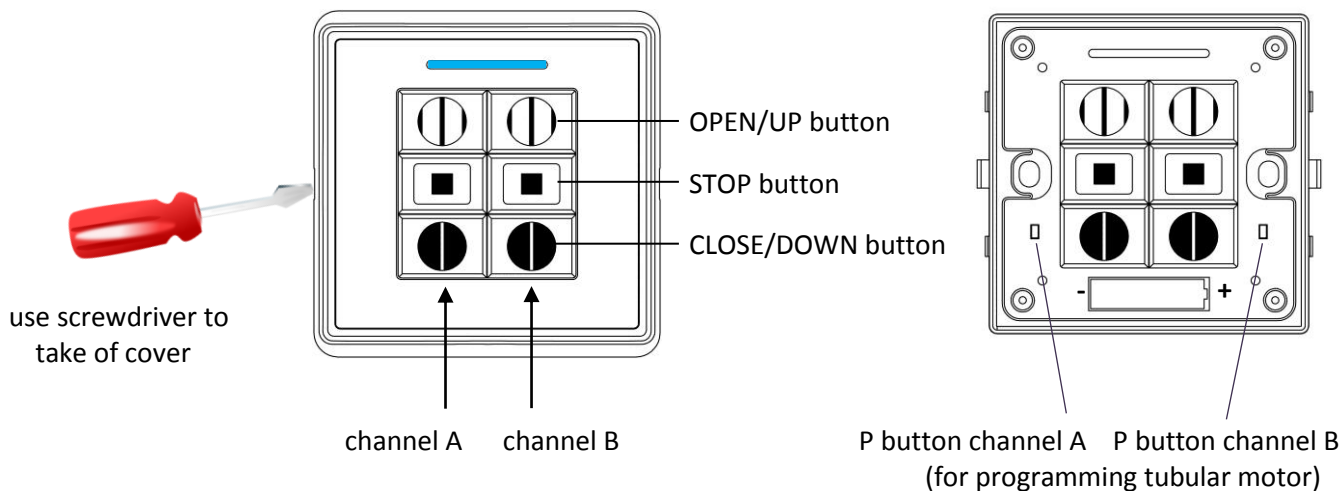

BATTERY EMPTY:

After changing the battery, programmed receivers will stay in memory of wall switch. Please follow the local regulations for disposal of the empty battery.

To program a RF wall switch to a Shuttle S / L:

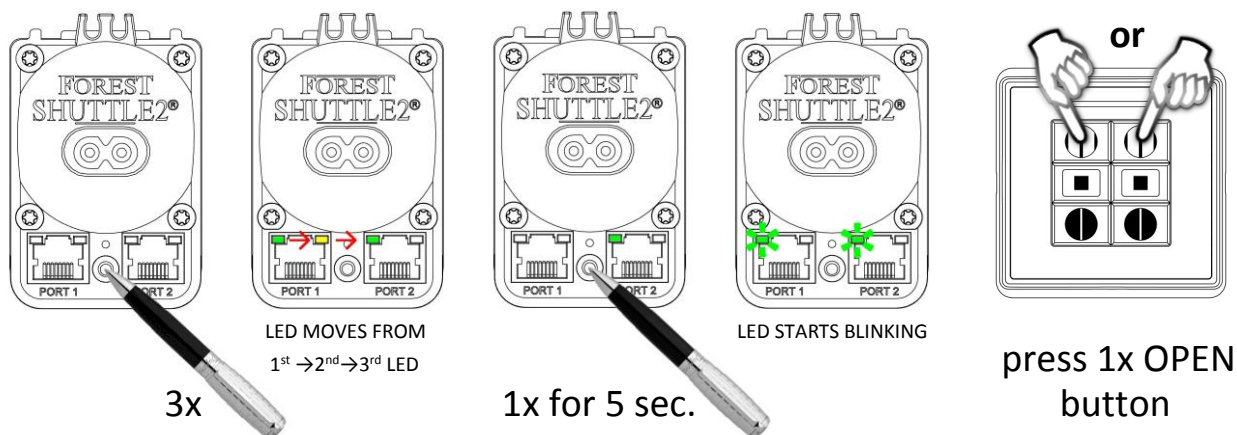

Same procedure, but press CLOSE instead of OPEN, will erase the programmed channel.



Do not mount the motor within 1 meter from other equipment and receivers. This will interfere with the receiver.

TECHNICAL SPECIFICATION:

- powered by Shuttle M
- connect to port 1 of the Forest Shuttle M
- working temperature -10°C - +50°C
- controlled by Forest Multi Remote and Forest Multi Wall Switch RF

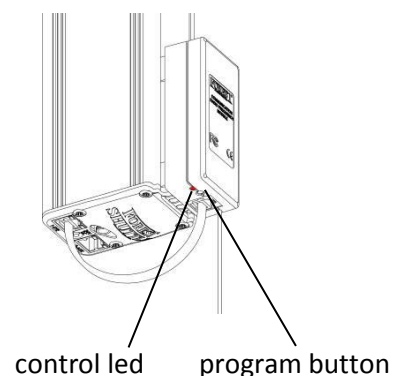

Do not mount within 1 meter from other equipment and receivers.
This will interfere with the receiver.

PROGRAMMING WALL SWITCH TO CLICK-ON RECEIVER:



press program button,
led will light up

hold the wall switch within 2 meter
from receiver. Select channel A or B
and press OPEN button

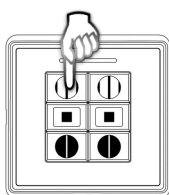

led blinks 3 times and will go off

REMOVE PROGRAMMED CHANNEL:



press program button,
led will light up

select (to be cancelled) channel A or B
and press CLOSE button

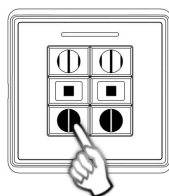

led will blink and will go off

DELETE ALL PREVIOUS PROGRAMMED CHANNELS:



press and hold the program
button for 10 seconds until
control led starts blinking

TECHNICAL SPECIFICATION SHUTTLE M RECEIVER:

- powered by Shuttle M
- can also be used as wall switch
- cable 0,5mtr → 5201001360
- cable 3,5mtr → 5201001361
- connect to port 1 of the Forest Shuttle M
- working temperature -10°C - +50°C
- controlled by Forest Multi Remote and Forest Multi Wall Switch RF



use screwdriver
to take of cover

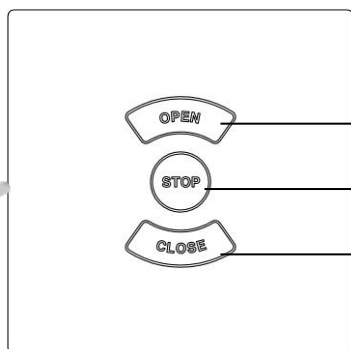

OPEN/UP button

STOP button

CLOSE/DOWN button

TECHNICAL SPECIFICATION FMS/BCS RECEIVER:

- power 230Vac – 500W
- controls one tubular or FMS motor
- can also be used as wall switch
- terminal max 2,5mm²
- working temperature -10°C - +50°C

program button control led

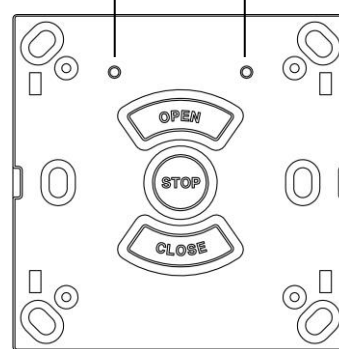

PROGRAMMING WALL SWITCH TO RECEIVER:

press program button, led will blink

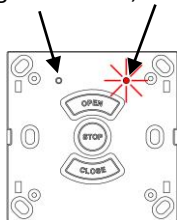

press STOP button

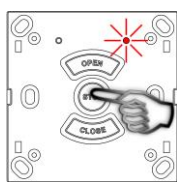

hold the remote within 2 meter from receiver. Select channel A or B and press OPEN button:

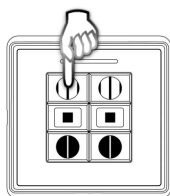

led blinks 3 times and will go off

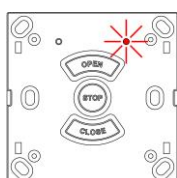

REMOVE PROGRAMMED CHANNEL:

press program button, led will blink

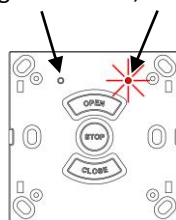

press STOP button

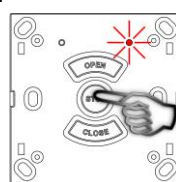

select (to be removed) channel A or B and press CLOSE button:

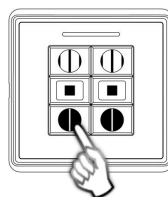

led will blink and will go off

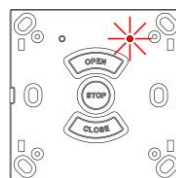

DELETE ALL PREVIOUS PROGRAMMED CHANNELS:

press STOP and CLOSE button of receiver for ~6 sec.

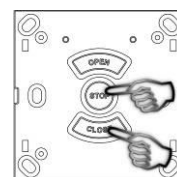

led will blink and will go off

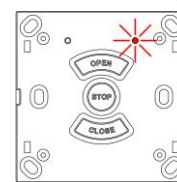

Do not mount within 1 meter from other equipment and receivers. This will interfere with the receiver.

TUBULAR MOTOR

BUILD-IN RECEIVER AND ELECTRONIC LIMIT SETTING

PROGRAMMING WALL SWITCH TO TUBULAR MOTOR:

press button on motor, motor will turn short to acknowledge

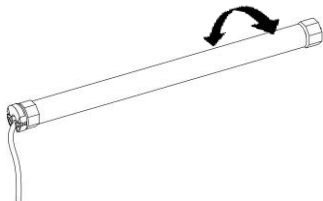

within 6 seconds:

press P button two times

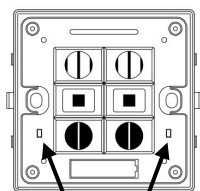

OR
2x P

press OPEN button one time

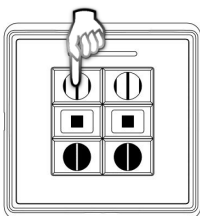

motor will turn to acknowledge

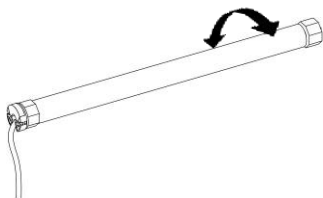

CHANGING DIRECTION OF ROTATION

To change the direction of rotation, keep green button on motor pressed for 7 sec, until motor turns to acknowledge.

ADD MORE WALL SWITCHES / CHANNELS TO TUBULAR MOTOR

①st wall switch: press P button two times

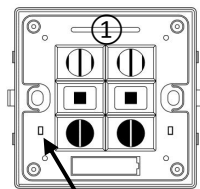

2x P

②nd wall switch: press P button one time

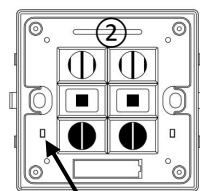

1x P

motor will turn to acknowledge

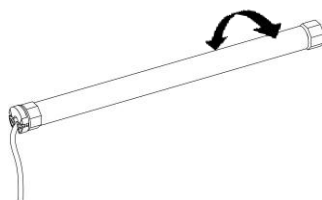

to add the other channel:

- 1.press 2xP2 button of programmed channel,
- 2.select other channel and press P2 button

motor will turn to acknowledge

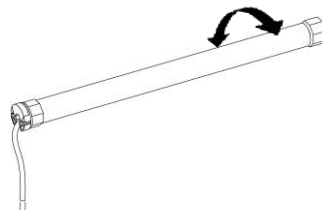

CANCEL ALL WALL SWITCHES

press P button one time

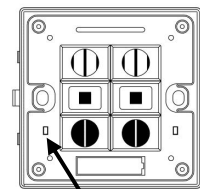

1x P

press STOP button one time

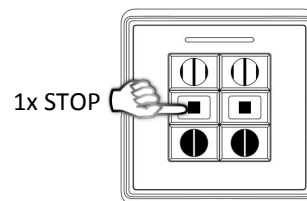

1x STOP

press P button one time

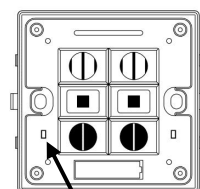

1x P

motor will turn to acknowledge

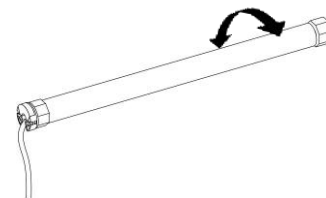

ADJUSTING UPPER AND LOWER END LIMITS:



IMPORTANT: - when more motors are programmed to one channel, end limits of all motors will be adjusted
- during programming, keep the wall switch within 2 mtr from the receiver/motor

This example is based on programming channel A (left side of wall switch).

press P button one time

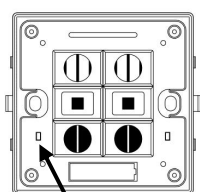

1x P



press OPEN button one time

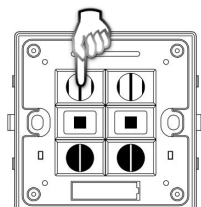

press P button one time

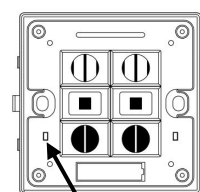

1x P

motor will turn to acknowledge

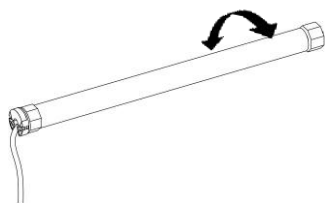

adjust to UPPER position

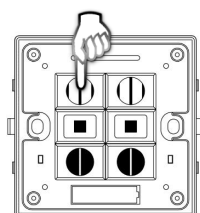

press STOP button when required height is reached. Press STOP button **5 times slowly for 1 seconds** to confirm

5x STOP (slowly)

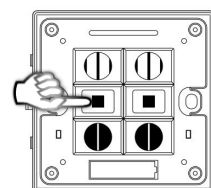

motor will turn to acknowledge

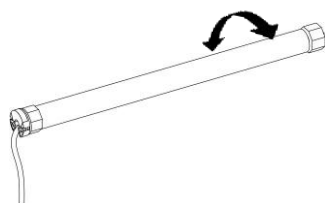

adjust to LOWER position

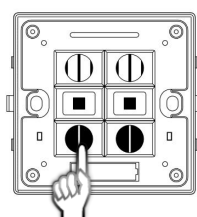

press STOP button when required height is reached. Press STOP button **5 times slowly for 1 seconds** to confirm

5x STOP (slowly)

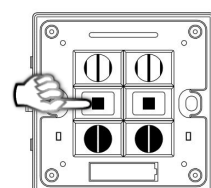

motor will turn to acknowledge, limits have been set successfully.

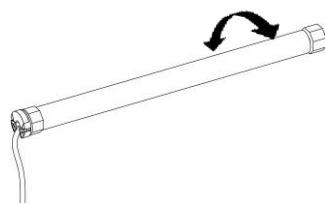

CANCELLATION OF UPPER AND LOWER END LIMITS:



IMPORTANT: When cancelling end limits, all motors programmed to that channel will be cancelled

press P button one time

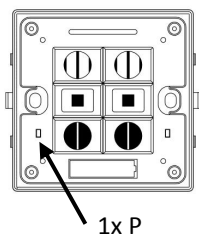

press CLOSE button one time

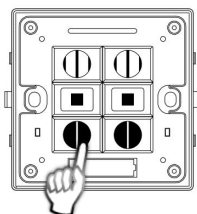

press P button one time

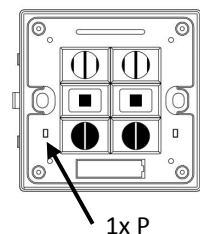

motor will turn to acknowledge

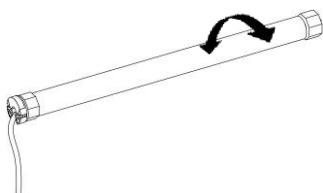

REVERSE DIRECTION SETTING:

When motor is not running, press button on motor for ~ 7 seconds, until motor turns to acknowledge.

TECHNICAL SPECIFICATION:

- 24Vdc, 16Watt
- nom. 0.8Nm – max. 1.0Nm
- 34 rpm
- max. running time 7 min.
- max. curtain weight 4 kg
- max. 5 cord rolls
- has to be used with Multi remote and/or Multi wall switch RF
- only to be used in Forest BS system and with Forest power supply for BS motor



IMPORTANT: WHEN USING THE QUICK LOCK CORD ROLL, BE SURE TO LOCK THE CORD BEFORE USING THE MOTOR

PROGRAMMING WALL SWITCH TO BS MOTOR:

switch on power to the motor:



motor will jog to acknowledge:

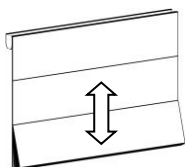

within 10 seconds, select side A or B, press P button and press OPEN button

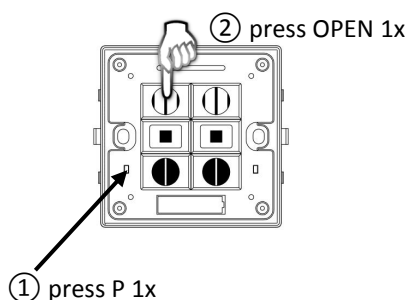

motor will jog to acknowledge:

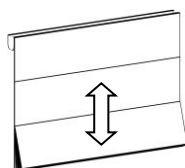

REMOVE PROGRAMMED CHANNEL

switch on power to the motor:



motor will jog to acknowledge:

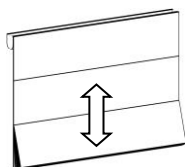

within 10 seconds, select side A or B, press P button and press STOP button

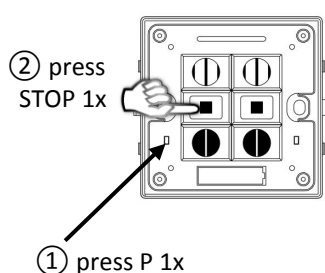

motor will jog to acknowledge:

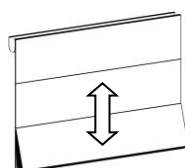

CHANGE MOTOR DIRECTION

switch on power to the motor:



motor will jog to acknowledge:

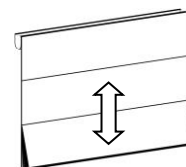

within 10 seconds, select side A or B, press P button and press CLOSE button

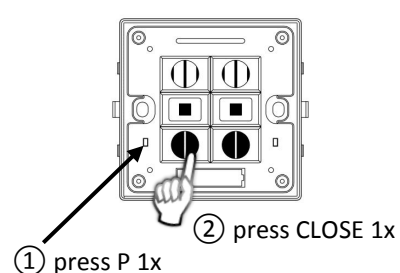

motor will jog to acknowledge:

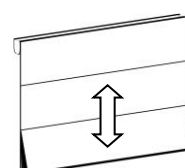

NOTE: if you need to start over, switch off the power and wait at least 20 seconds before switching in the power

SET UPPER END LIMIT

press P button once,
motor will jog to acknowledge:

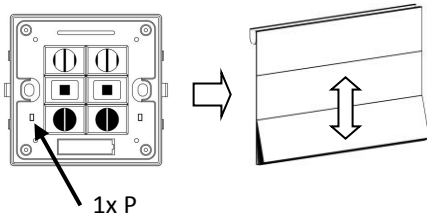

press OPEN button once,
motor will jog to acknowledge:

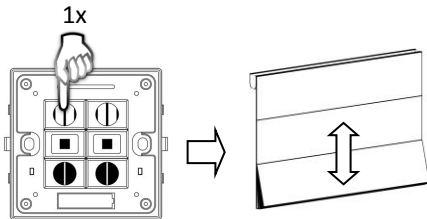

press P button once,
motor will jog to acknowledge:

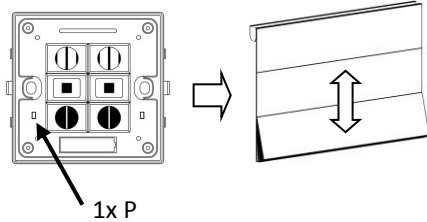

adjust desired upper end limit and
press P to save the upper limit:

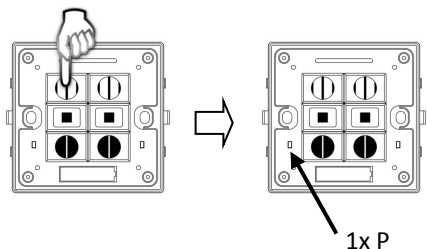

motor will jog to acknowledge:

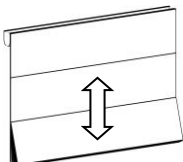

SET LOWER END LIMIT

press P button once,
motor will jog to acknowledge:

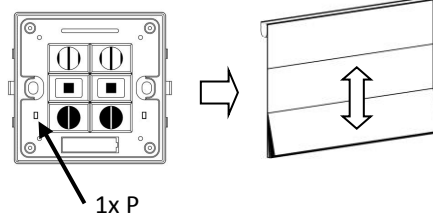

press CLOSE button once,
motor will jog to acknowledge:

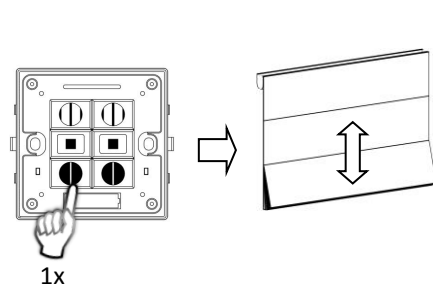

press P button once,
motor will jog to acknowledge:

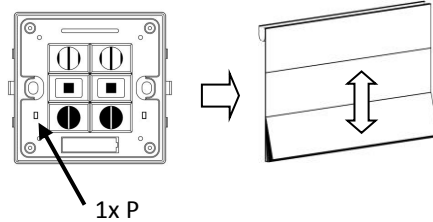

adjust desired lower end limit and
press P to save the lower limit

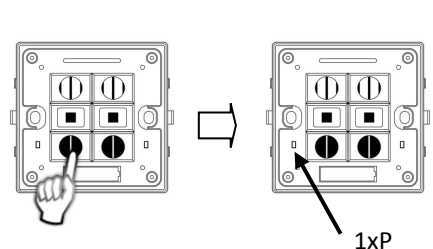

motor will jog to acknowledge:

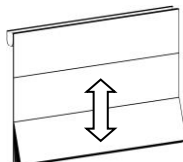

DELETE LIMITS

press P button twice,
motor will jog to acknowledge:

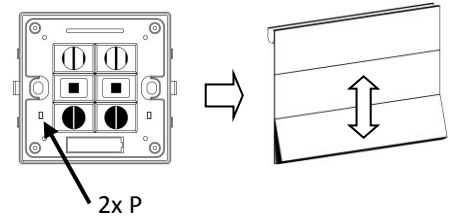

press OPEN button once,
motor will jog to acknowledge:

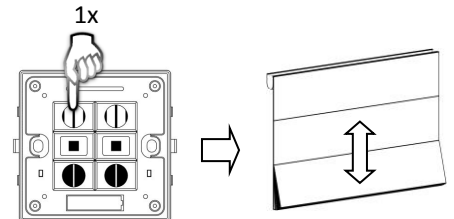

DELETE ALL MEMORY

press P button twice
motor will jog to acknowledge:

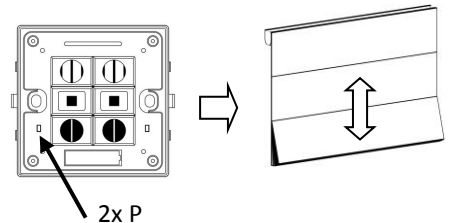

press CLOSE button on remote,
motor will jog twice to acknowledge

