

Colours available
Complete the art.nr. with the indicated colour-code.

01 White
03 Silver
11 Off-white

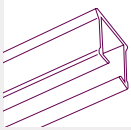

CS Track
Extruded aluminium chromated, powder-coated. Factory lubricated for wall or ceiling mounting. Inches 3.66 m. (12 ft.), 4.27 m. (14 ft.), 4.88 m. (16 ft.), 6.10 m. (20 ft.). Colours: 01, 03, 11.

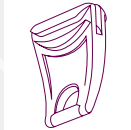

Carrier
Contract klik carrier patented, klickable, comes 5 on a break away strip. Colours: 01, 03, 11.



Economy slide
Can turn in the track. White.



Ball Bearing Carrier Slim line
30 % less stack back. Clear.



Ball Bearing Carrier
Conventional size. Clear.

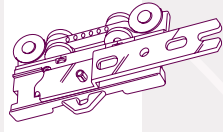

Master Carrier R/L
Underlap right or left. For stiffener and exposed or hidden wand.

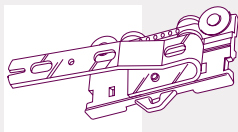

Master Carrier R/L
Overlap right or left. For stiffener and exposed or hidden wand.

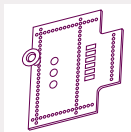

Stiffner large with grommet
Adjustable for wall or ceiling mount.

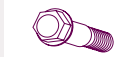

Hex head shoulder screw
To attach baton to master carrier.



Baton adaptor
Clear.



Endcap with screw
Can be used with economy slide.

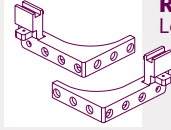

Return plate
Left and right for hooks or snaps. White.
Return plate left:
Return plate right:



Baton Fiberglass
With harness snap in White. 92 cm (36"), 122 cm (48"), 152 cm (60").

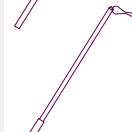

Baton with metal core
With harness snap in Transparent. Hexagonal shape. 100 cm (39 3/8"), 125 cm (49 1/4"), 150 cm (59").

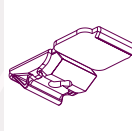

Smart Klick Ceiling Bracket
"Klicks" onto track, powder coated. Install with VK screw 4 mm. Colours: 01, 03, 11.

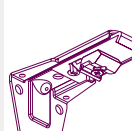

Adjustable Wall bracket
Smart klick, adjustable single from 7,5 cm (3") to 11,5 cm (4.5")

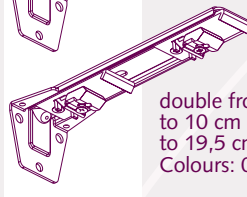

double from 6,5 cm (2.5") to 10 cm (4") - 15 cm (6") to 19,5 cm (7,5")
Colours: 01, 03, 11.

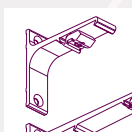

Aluminium Wall bracket
Smart klick, powder coated. Colours: 01, 03, 11.

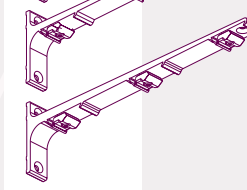

7,5 cm single (3") 20/box
10 cm single (4") 20/box
15 cm double (6") 15/box
20 cm double (8") 15/box
25 cm triple (10") 10/box

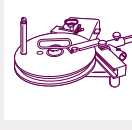

Bending tool
Includes 20 cm (8") radius wheel and bending strips. For CS/CCS track.

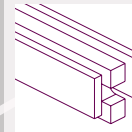

Replacement bending strips
For CS track, length 1 meter (39 3/8"). 2560100000 1/set
For CS electric powered bender. Length 7 meter (23'). 2560600000 1/set

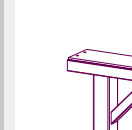

Bending standard
Standard for CS/CCS bending tool 2560800000 1/each

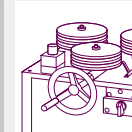

Electric powered bender
Available in 220V or 110V, to create continuous curves and arches. Minimum radius 50 cm (19 11/16"). Includes set of 3 CS/CCS wheels and CS bending strips. For CS/CCS track only.



Bending wheels
For electric powered bender. Complete set of 3 wheels. For CS/CCS track only.

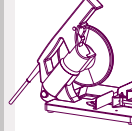

Electric powered railcutter
Available in 220V or 110V. On-site tool. Clean cut using aluminium cutting blade.

Replacement blade
For electric powered railcutter.

Distributor:

FOREST

DRAPERY HARDWARE



FOREST

DRAPERY HARDWARE

GS
Contract System

Product information

- Heavy duty hand drawn system for medium and heavy draperies.
- Bendable; it can be curved and reversed curved using a 20 cm (8") radius or continuous curved.
- Heavy duty clickable carriers - 5 carriers on a breakaway strip - UV protected. Can also be used with ball bearing carriers.
- Ideal for use with overlap masters and batons which can be mounted behind or in front of draperies.
- Can also be used for ripplefold and accordiafold drapery systems.
- Maximum fabric weight: 8 kg. p. mtr (6 LBS per ft).
- Colours available: white, silver and off-white
- Track finish: chromated powder coated with a factory applied patented dry lubricant.
- Available lengths: 3.66 meter (12 ft.), 4.27 meter (14"), 4.88 meter (16 ft.), 6.10 meter (20 ft.)
- Limited lifetime warranty.

Applications

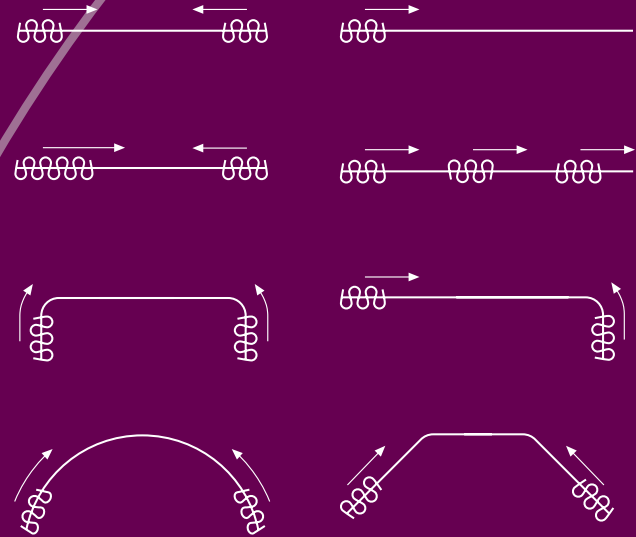

Features

- Stiffner is sewn onto drapery overlap
- Stiffner socket is placed into master arm
- Baton is attached by a screw through the eyelet and into the master arm.

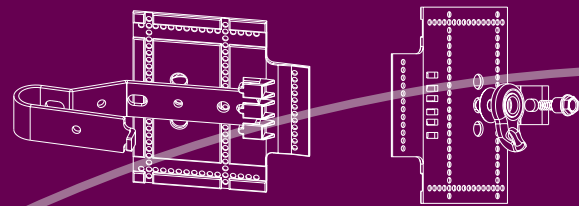

For use in

- Hotels - Motels - offices - schools - healthcare residential or anywhere a heavy duty hand drawn system is required.

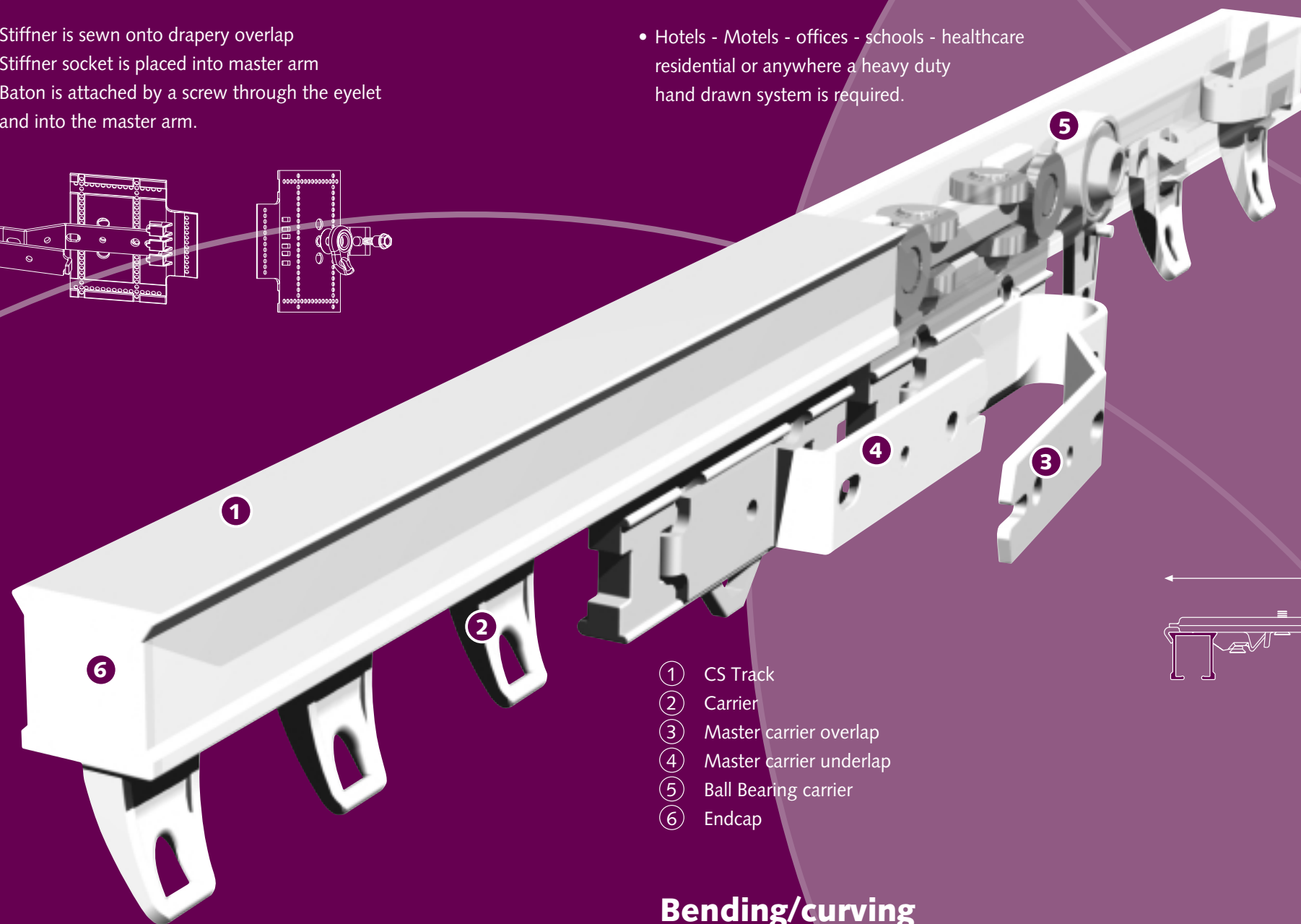

- 1 CS Track
- 2 Carrier
- 3 Master carrier overlap
- 4 Master carrier underlap
- 5 Ball Bearing carrier
- 6 Endcap

Profile

Shown actual size 1:1. Weight: 235 gram p. mtr (2.53 ounce - ft). Aluminium extrusion 6063 T5
Dimensions: 20 mm x 20 mm (3/4" x 3/4").

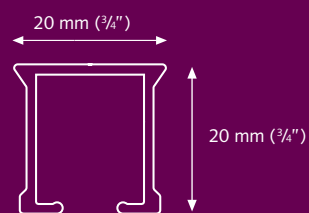

Bending/curving

The track can be curved and reversed curved using a 20 cm (8") radius. Continuous curving is also available by special order from factory only.

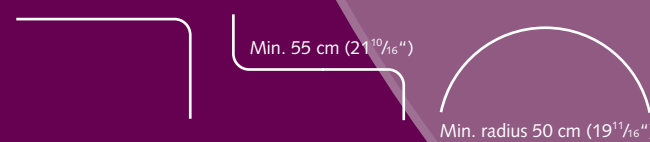

Bending instruction leaflet enclosed.

Mounting Brackets

Ceiling bracket

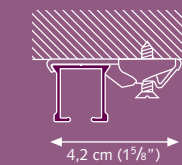

Adjustable wall bracket

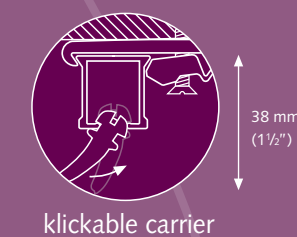
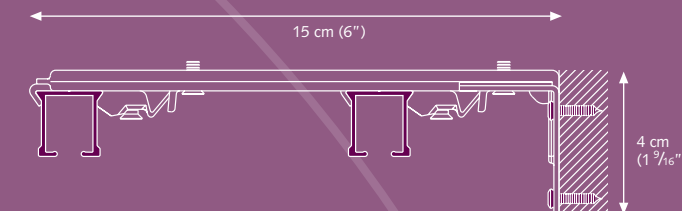
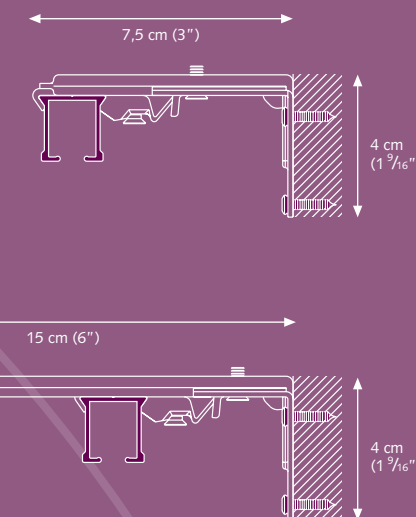

clickable carrier



Easy installation
click - position - tighten

Mounting Brackets

Wall bracket aluminium single

- 7,5 cm (3")
- 10 cm (4")
- 15 cm (6")

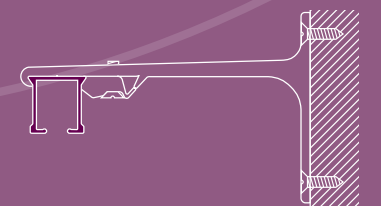

Wall bracket aluminium double

- 15 cm (6")
- 20 cm (8")

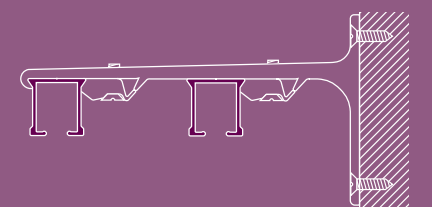

Wall bracket aluminium triple

- 25 cm (10")

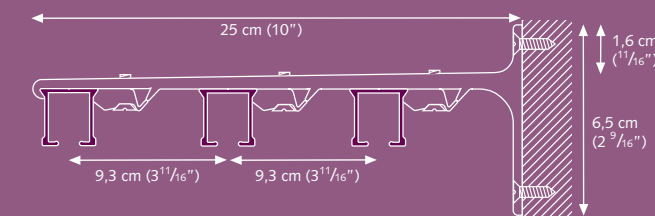

Other brackets are available, see component listing.
Two brackets at each end 60 cm (24") apart and up to 95 cm (36") over remainder of track depending on weight of treatment.