

**Colours available:**

**Where necessary, complete the art.nr. with the indicated colour-code.**

**25 White**

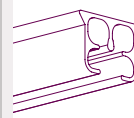

**CKS Track** 15010.. .00 cm  
Aluminium extrusion, powder coated, lubricated. Colours 01. 20/bundle  
Available lengths: 4 m. (13'1"), 1113-25  
5 m. (16'4"), 1116-25  
6 m. (19'8"), 1119-25



**Carrier** 2001 ..  
50 strips of 10 500/box  
For French Pleat - Pinch Pleat  
can be clicked in after installation offset  
shape to help pleats hang straight.  
Colours: 25, 59, 63, 65, 90.

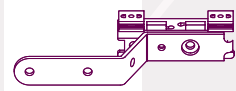

**CKS Master Carrier Overlap** 2529-25  
Will go through curves. 25/box  
Colours: 01.

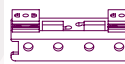

**CKS Master Carrier Underlap** 2530-25  
Will go through curves. 25/box  
Colours: 01.

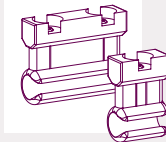

**CKS Cord Connector** 2531-25  
Connects cord to the CKS Master 100/box  
Carrier. Colours: 01.

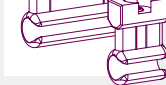

**CKS Cord Connector half** 2532-25  
Connects cord to the CKS Master 100/box  
Carrier. Special item for adjusting the  
cord-length. Colours: 01.

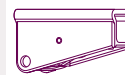

**CKS End Pulley** 2804-25  
Reversible, for two way draw. 25/box  
Colours: 01.

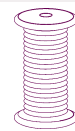

**Traverse Cord** 9004-25  
Nylon drapery cord designed for 250 mtr/roll  
strong smooth slide, #3.5 16 ply.  
Bead chain is optional.  
Colours: 01.

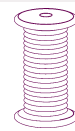

**Traverse Chain** 3535501000  
Nylon chain Balls, recommended for 250 mtr/roll  
more then 2 curves. Colours: 01.

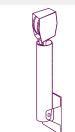

**Tension Pulley** 9005-25  
Plastic, white. 25/box

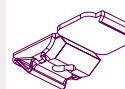

**Smart Klick Ceiling Bracket** 3003-25  
Heavy duty, can be used with all 100/box  
KS Track Systems.  
Colors: 25, 90.

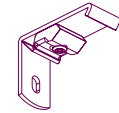

**Smart Klick Wall Bracket** 50/box  
Regular duty 3/4" clearance, 10202..035  
can be used with all KS Track  
Systems. 10202..060  
Colors: 25, 59, 63, 65, 90.

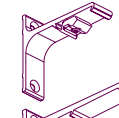

**Aluminium Wall bracket**  
Smart klick, powder coated.  
Colors: 25, 90.  
Single 3" 3280 .. 20/box  
Double 6" 3281 .. 15/box  
Triple 10" 3283 .. 10/box

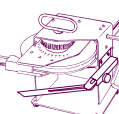

**Compact Bending tool** 5002-25  
Includes 2" filler strip for basic angles 1/each  
(90, 45, bay windows, etc...),  
use for regular KS Track only.  
Includes intruactional video.

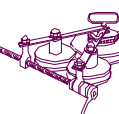

**Continuous Curver** 5003-25  
Add on tool for the Compact Bending 1/each  
tool. Designed to create continuous  
curves and arches in any radius.  
Includes bending strip.  
For CKS/KS track only.

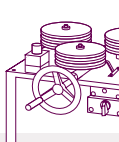

**Electric powered bender** 5004-00  
Available in 220V or 110V, 1/each  
to create continuous curves and  
arches. Minimum radius 50 cm  
(19 11/16"). Includes set of  
3 KS wheels and bending strip.

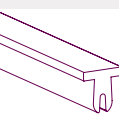

**Replacement Bending Strip  
for CKS Track** 5309-00  
For Compact Bending Tool. 1/each  
Length of strip: 60 cm (23")  
For Continues Curver / electric bender. 1560300000  
Length of strip: 7 mtr. (23") 1/each



**KS/CKS Bending wheels** 5304-00  
For electric powered bender. 1/set  
Complete set of 3 wheels.  
For CKS/KS track only.

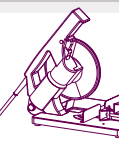

**Electric powered railcutter** 5051-00  
Available in 220V or 110V. On-site tool. 1/each  
Clean cut using aluminium cutting blade.



**Replacement blade** 5352-00  
For electric powered railcutter. 1/each

Distributor:

# FOREST

DRAPERY HARDWARE



# FOREST

DRAPERY HARDWARE

**CKS**<sup>®</sup>  
Corded Klick System

## Product information

- Highly efficient cord traversing system with separate internal cord channels; preventing cord sag and eliminating cord tangle
- Quick installation with "Smart Klick" brackets for wall and ceiling applications.
- Bendable; it can be curved and reverse curved by using a 10 cm (4") radius or continuous curve.
- Heavy duty klickable carriers - UV protected - for smooth and easy traversing. Offset shape for straight hanging pleats.
- Can also be used for ripplefold or accordiafold drapery systems.
- Maximum fabric weight:  $\pm 4$  kg per meter (3 LBS per ft.).
- Colours available: white.
- Available lengths: 4 meter (13'1"), 5 meter (16'4"), 6 meter (19'8").
- Track finish: chromated powder coated with a factory applied patented dry lubricant.
- Limited lifetime warranty.

## For use in

Hotels - offices - residences - boats - campers - planes or anywhere an efficient cord traversed system is required.

## Applications

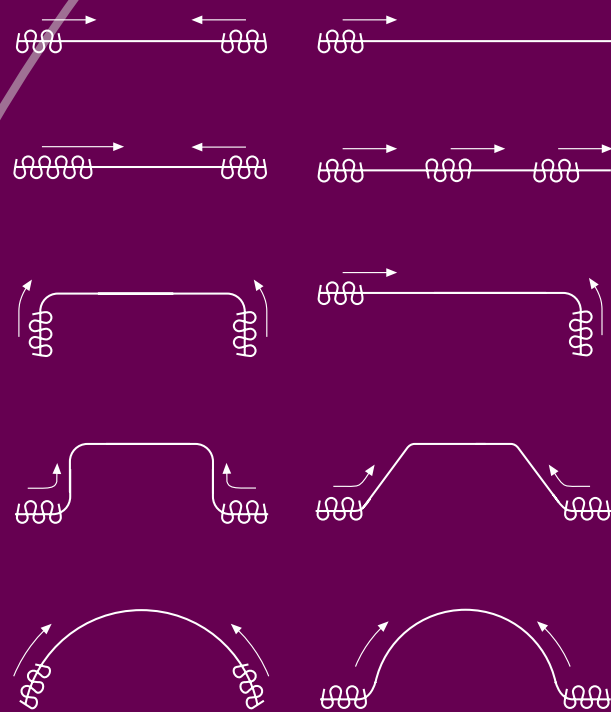

Bending instructions available

## Bending/curving

The track can be curved and reverse curved using a 10 cm (4") radius. Continuous curving can easily be done using the continuous curver or the electric powered bender or available by special order from factory.



## Profile

Shown actual size 1:1  
Weight: 202 grams per meter (2.17 ounce per ft.)  
Aluminium Extrusion 6063 T5.  
Dimensions: 14 mm x 20 mm (9/16" x 3/4").

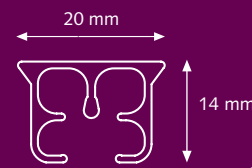

- 1 CKS Track
- 2 KS Carrier
- 3 CKS Master Carrier Overlap
- 4 CKS Master Carrier Underlap
- 5 CKS Pulley

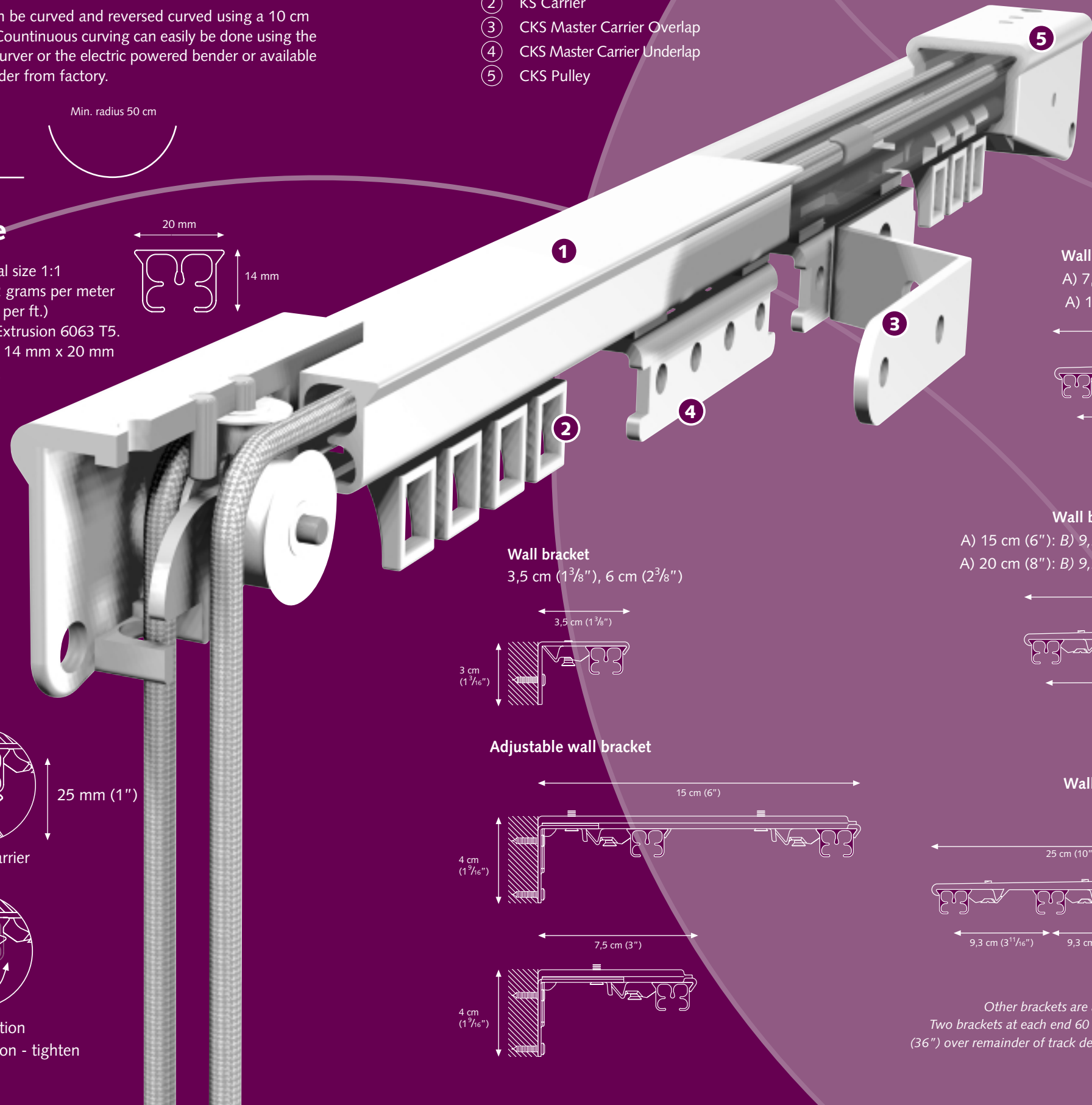

## Mounting Brackets

### Ceiling Bracket

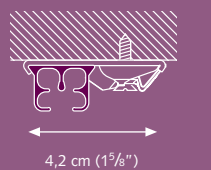

### Wall bracket aluminium single

A) 7,5 cm (3") : B) 6,3 cm (2 1/2")  
A) 10 cm (4") : B) 8,8 cm (3 1/2")

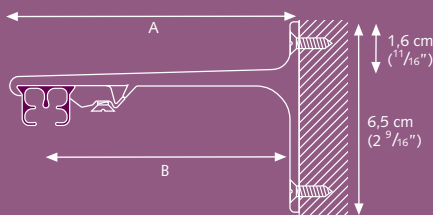

### Wall bracket aluminium double

A) 15 cm (6") : B) 9,2 cm (3 1/2"), C) 4,5 cm (2")  
A) 20 cm (8") : B) 9,2 cm (3 1/2"), C) 9,5 cm (4")

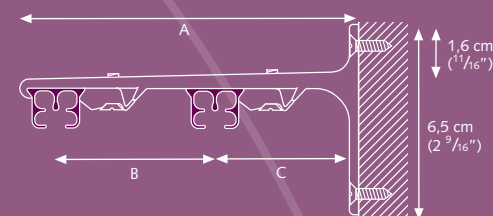

### Wall bracket aluminium triple

25 cm (10")

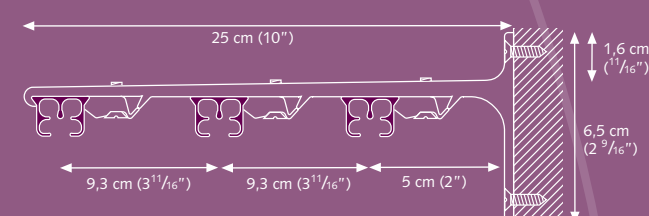

### Wall bracket

3,5 cm (1 3/8") : 6 cm (2 3/8")

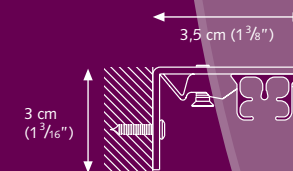

### Adjustable wall bracket

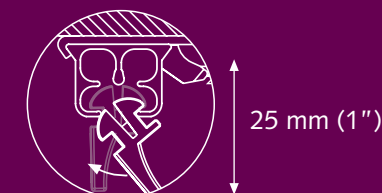
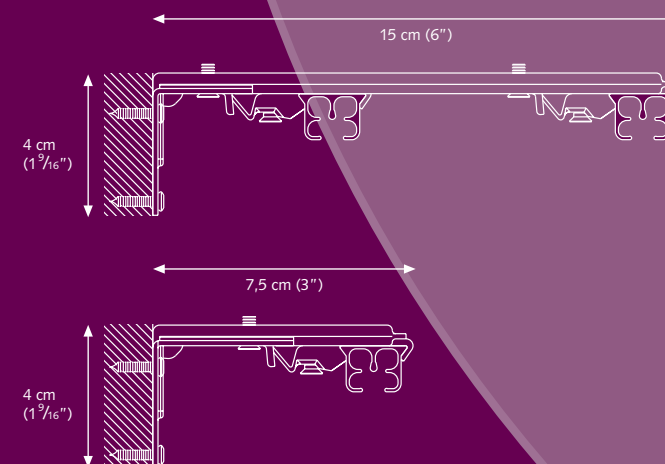

clickable carrier



Easy installation  
klick - position - tighten

Other brackets are available, see component listing  
Two brackets at each end 60 cm (24") apart and up to 95 cm (36") over remainder of track depending on weight of treatment